

bit ONE

**PROGRAMMABLE
POLYPHONIC
TOUCH SENSITIVE
SYNTHESIZER**

OWNER'S MANUAL

by Guido Dall'Oglio

FRONT PANEL

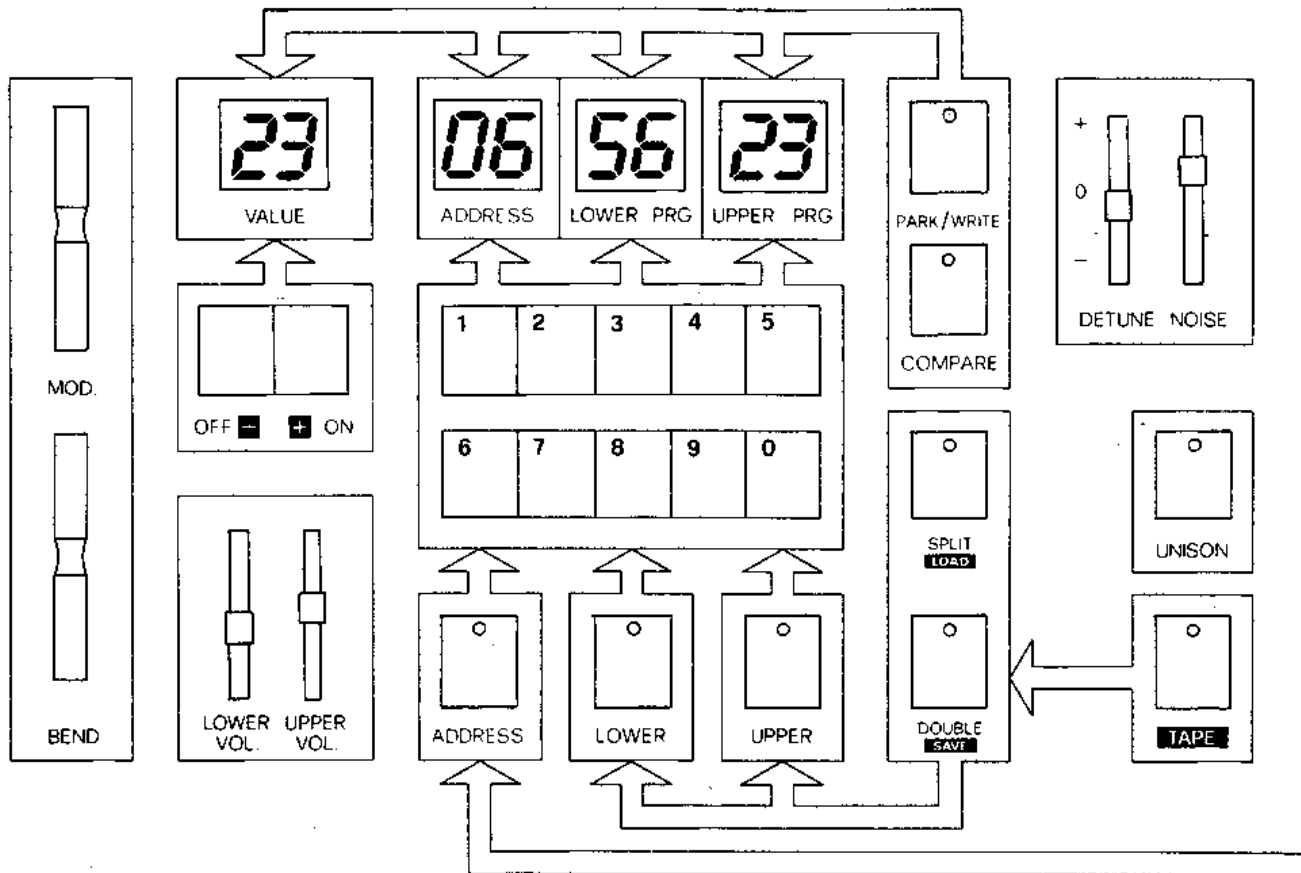

BIT ONE: CONNECTION

- 1) Make sure that your local AC voltage is the same indicated on the rear of the instrument 117 or 220 Volt.
- 2) Connect with the AC cable, supplied with the instrument, the BIT ONE and an AC wall socket.
- 3) You can now activate the on/off switch.

AMPLIFICATION

The two audio outputs of the instrument are marked Lower and Upper, and they are standard 1/4' type jacks.

The output level is compatible with every amplifier system, P.A. system or domestic recording system either professional (+4db) and semiprofessional (-10db). The max. output level is = 0 db (0,7 volt RMS into 600 ohm.). In order to fully appreciate the timbric quality of the BIT ONE, is recommended the use of a stereo amplifier with extended frequency range and multiway speakers in order to reproduce with sufficient linearity the entire range of frequencies sent out from a synthesizer.

It is much better the use of a low powered Hi-FI system, rather than guitar or bass amplifier. It is possible to connect the BIT ONE to your HI-FI system utilizing the AUX inputs of your amplifier and carefully balancing the output volume of the instrument.

AUDIO OUTPUT «MONO AND/OR STEREO»

The main audio output is the «Upper Out», from which come out either the voices played in Lower Prog. than the voices played in Upper Prog.

Upper Out is also the Mono output of the BIT ONE.

Connecting also the Lower Out, it takes away the Lower sound from the Upper output, becoming independent. The two outputs «Lower Out» and «Upper Out» can be addressed in Stereo mode.

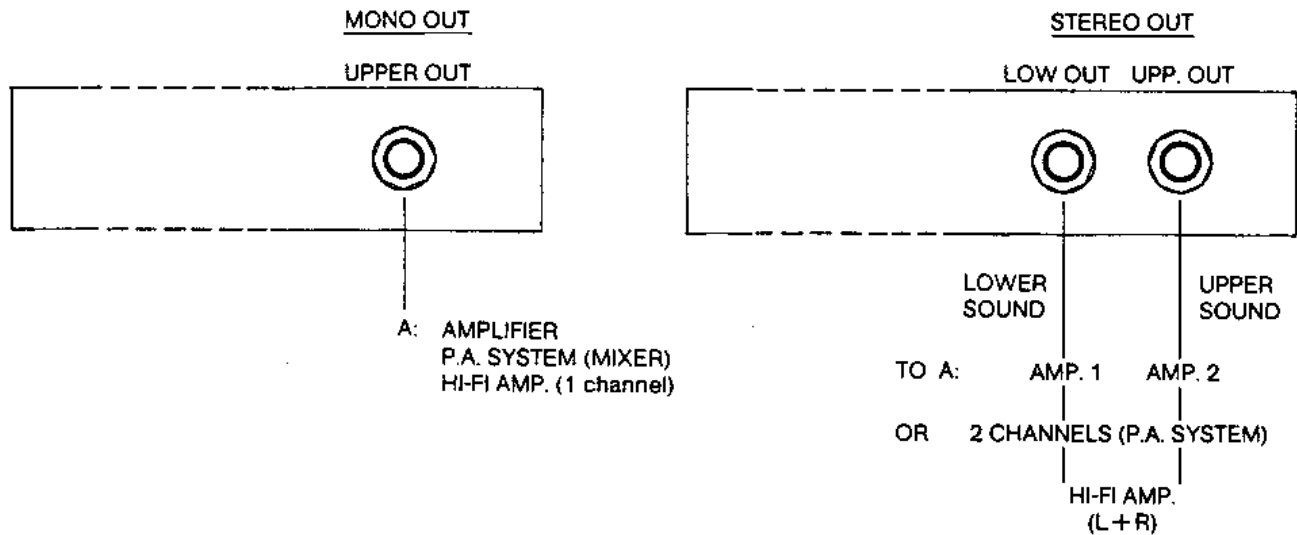

The type of Stereo effect obtainable, connecting both outputs (left/right) is different depending on which operative mode you are playing (Play mode Split or Double). More detailed information will be given during the reading of this manual.

BIT ONE: GENERAL CONTROLS

The general controls of the BIT ONE are always in function, independently of which operative mode (Play/Double/Split/Unison/Edit) you are playing. They do not function only when you are in Tape mode.

The general controls are not programmable, they do not belong to those parameters «reminded» by the memory of the BIT ONE.

VOLUME SECTION

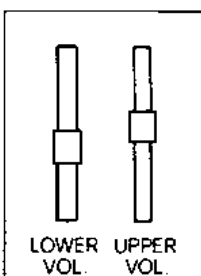

The volume section controls the output volume of the instrument and also the balancing of the Lower and Upper sounds when you are in Double and Split. It contains two sliders marked Lower and Upper volume.

If you play in «Play Mode» (all 6 voices for Lower sound), **the slider Lower has to be positioned always at maximum**, this in order to avoid an unbalance between the first 3 voices and the 3 second ones.

The general level is controlled by the slider Upper.

In Double and Split mode (3 voices for Upper sound, and 3 voices for Lower sound) instead:
The Lower slider regulates the level of the Lower sound.

The Upper slider regulates the level of the Upper sound.

This will allow you to control the volume and the balance of the sounds.

DETUNE AND NOISE SECTION:

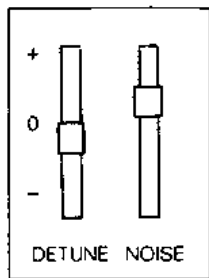

The «Detune and Noise» section is always functioning regardless from the operative modes. The Detune slider controls the tune of the DCO 2, it allows to shift the frequency of the same of $\pm 1/2$ tone in respect of DCO 1.

A proper use of this control is fundamental in order to give «body», fatness and animation to the sound, especially to the orchestral ones. A very light detuning generates a phasing with slow cycle and a continuous rotation but with harmonic contents still audible.

For bigger value of Detune you will obtain a real «animation» of the sound due to the increase of the velocity of the phasing cycle.

With the Detune you will get the effect of many instruments which are playing the same note.

The Noise slider regulates the White Noise level of the «Noise generator». The Noise generator of the BIT ONE is a generation source like the two DCO. Its audio signal can be treated by the VCF and VCA.

In order to have a preset with only Noise, you have to turn off the two DCO's in the Edit Map.

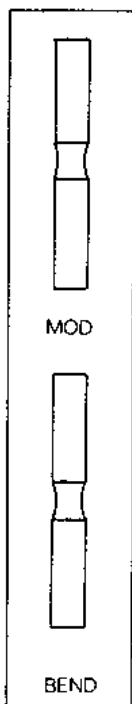

MODULATION WHEEL: it regulates the frequency modulation depth of the DCO's by the LFO's. Therefore it allows the introduction and the control of the depth of the various «modulations» available. (Refer the section LFO of the Edit Map).

If the preset you are playing does not include any modulation, this wheel does not have any effect.

PITCH BENDING WHEEL: it allows you to manually raise and lower the general pitch of the instrument, up to a range of ± 1 tone and half (\pm a minor third). This control is always functioning. In Double and Split modes it controls simultaneously the pitch of the two sounds.

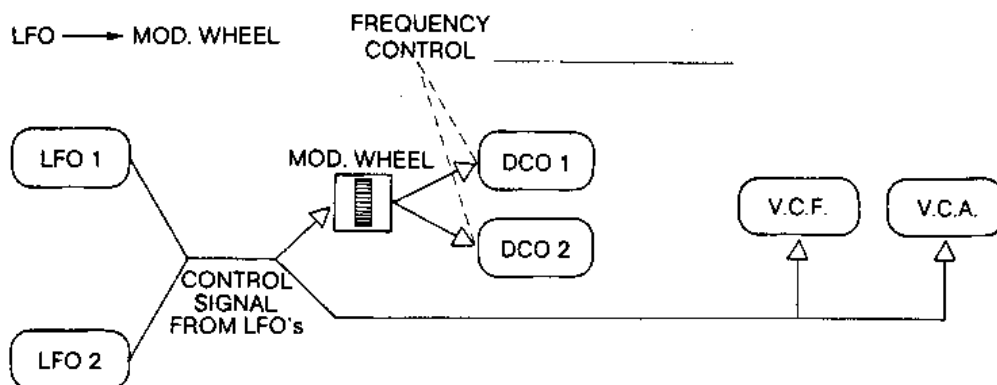

BIT ONE: OPERATIVE MODES

The BIT ONE has 5 different modes of operation:

PLAY MODE: it allows you to play on the entire keyboard one of the 63 presets loading it on Lower Prog.

DOUBLE and SPLIT MODE: they allow you to play simultaneously 2 of the 63 presets, loading them on Lower and Upper Prog. (In these modes the BIT ONE is «bitimbric»).

UNISON MODE: it turns the instrument «biphonic». You can play only two keys at time with 6 oscillators on each key.

EDIT MODE: it allows you to modify or to create new sounds acting on the parameters available.

TAPE MODE: it allows to transfer on tape or to load from tape all data of the sounds.

BIT ONE: LOWER AND UPPER PROGRAMMERS

The BIT ONE has two independent programmers where - you - can load the sounds existing in the memory: Lower Prog. and Upper Prog.

The 6 voices of the instrument can «draw» either all 6 notes from Lower Prog., or 3 notes from Lower and 3 notes from Upper Prog. This depend on the operative mode you have choosen on the BIT ONE.

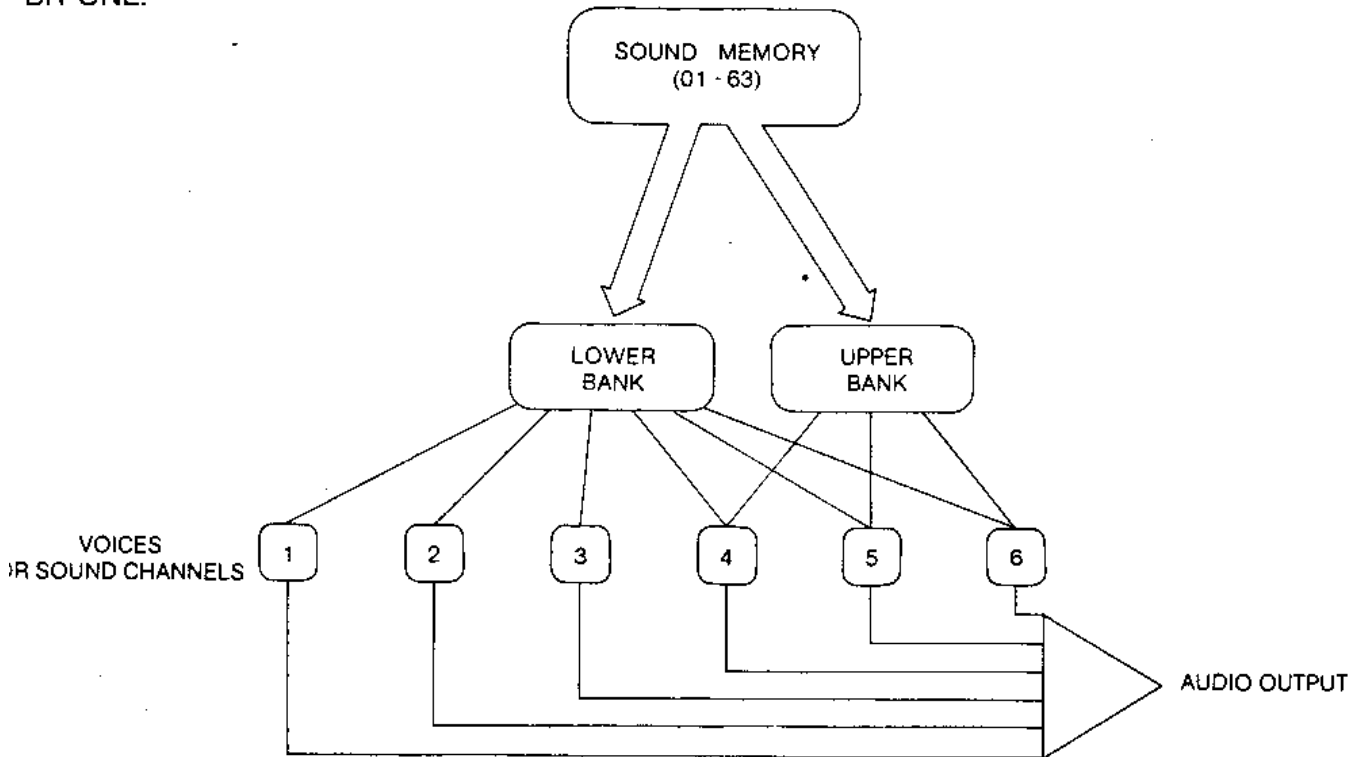

PLAY MODE: Select and listening of the 63 presets

In Play mode you can select and play all presets only on Lower programmer, with the availability of all 6 voices of the instrument.

In Play mode you can only activate the selector Lower, the Lower display, the Numeric Keyboard and all the general controls with the exception of the Upper selector, the relative display and Split and Double selectors. When you switch on the BIT ONE, if everything is OK, the instrument will automatically set itself in Play mode at preset n. 1.

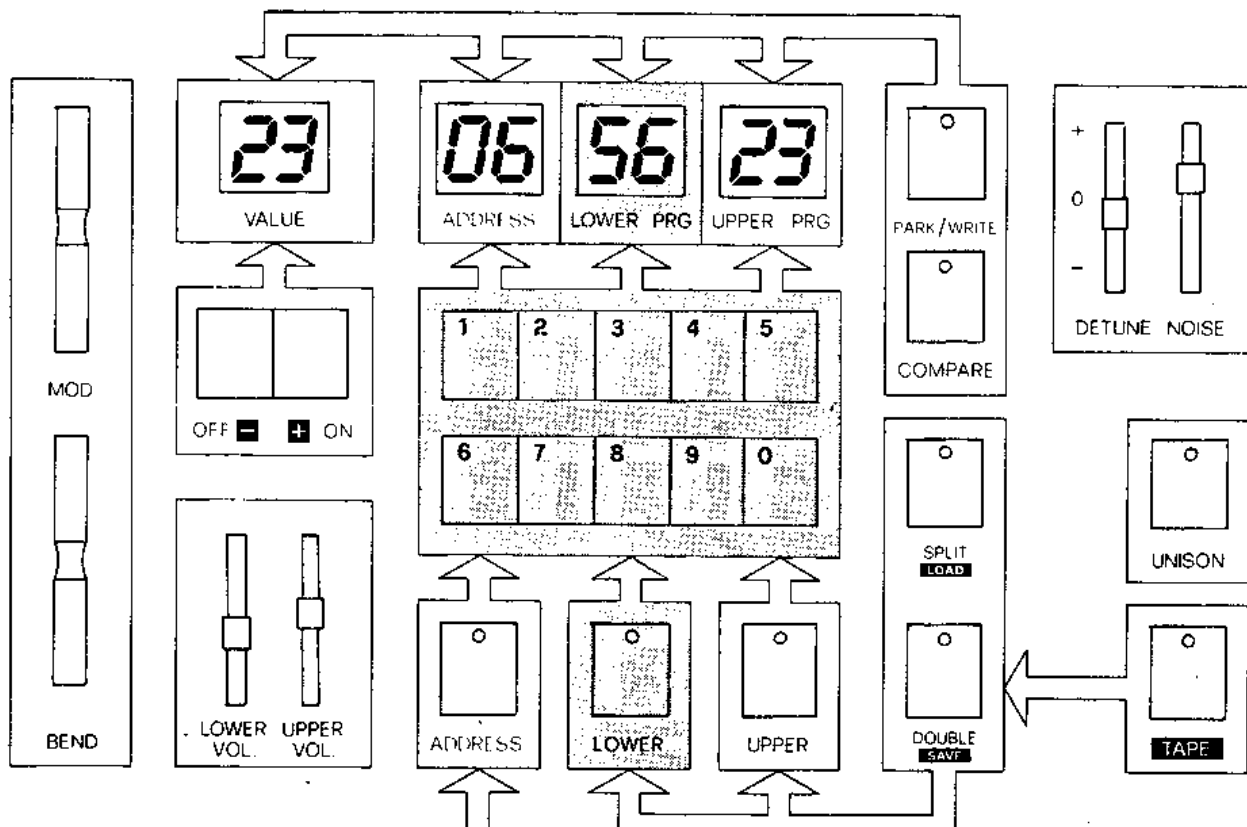

HOW TO SELECT AND PLAY ONE OF THE 63 PRESETS:

Press Lower selector (the led will light), compose on the numeric keyboard the desired program (note: for presets from 1 to 9, the number has to be always of two figures: 01, 02...09). The Lower display will indicate the program you choosen.

As long as the Lower selector is on you can select and play any program, simply by composing their relative numbers on the numeric keyboard, the Lower display will always indicate the last program selected.

Example:

Operation	Display	Sound
Switch on BIT ONE	01	preset 1
Press lower selector	01	preset 1
Compose n. 15	15	preset 15
Compose n. 24	24	preset 24
.....	etc.	etc.

NOTE: It is also possible to make the programs advance forward and backwards, by using the selectors + and - (this is possible only if you are in Play Mode).

The 63 factory presets available in the instrument are an example of the timbric capability of the BIT ONE. These presets do not pretend to satisfy your requirements, however they represent a guide to which you can refer when you create your own sounds. Before you modify or cancel any of the factory presets, we suggest you to listen all of them and carefully observe, in the way we will describe later on, the value of each parameters. This practice will give you a valid indication of how certain sounds have been created, or they could suggest you a new strategy of programming, to better achieve your goals. During the practice with the factory presets you should also familiarize with all the «general controls» described up to now: Volumes, Detune, Noise, Pitch Bend and Modulation wheels, and also with the use of the Release pedal.

THE PLAY MODE IS THE «MONOTIMBRIC» MODE OF FUNCTIONING OF THE BIT ONE.

PLAY MODE STEREO OUTPUT: when you are in play mode and you have connected both outputs (Lower out and Upper out) in order to have a stereophonic effect (Left/Right), the BIT ONE will assign the voices played in the stereo panorama, by choosing a random logic, which will correspond to the assignation Key/Voice.

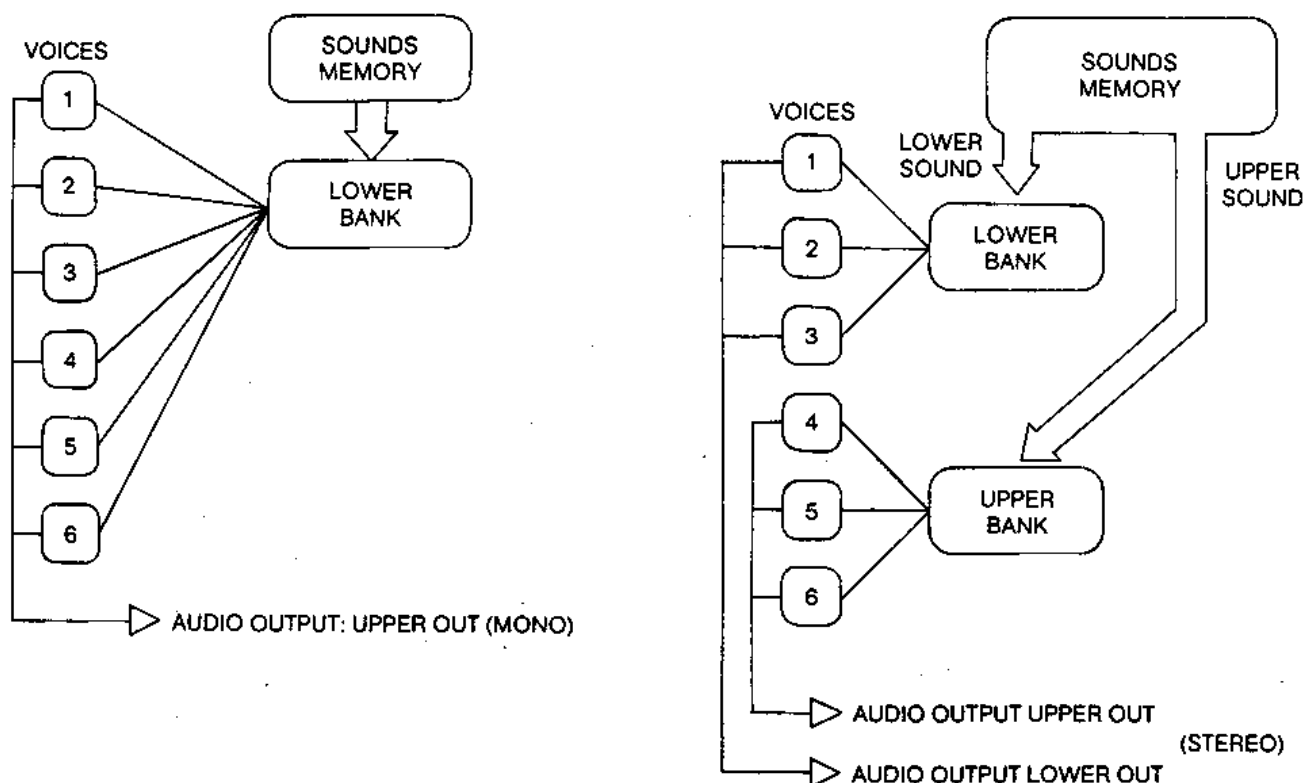

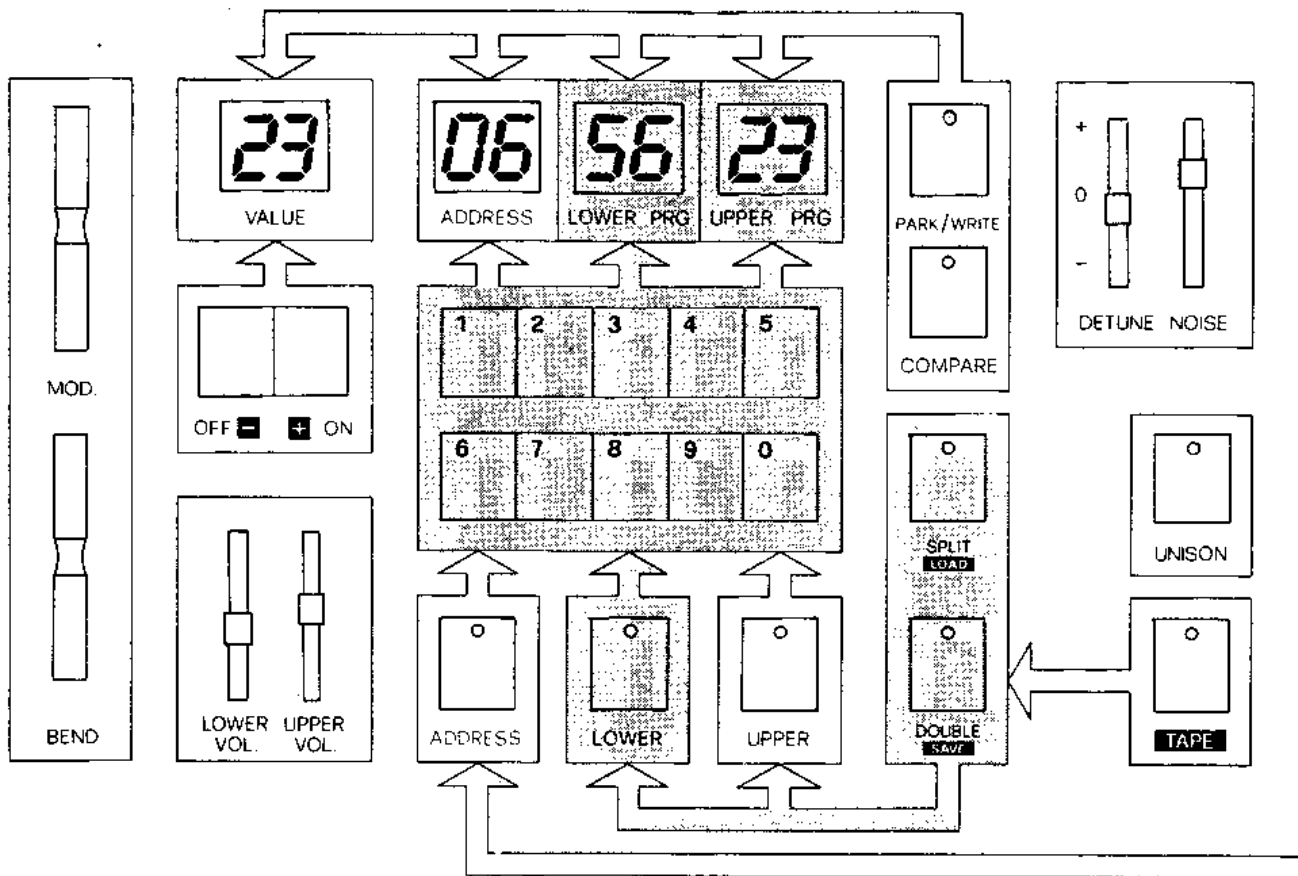

DOUBLE and/or SPLIT MODE

The Double and Split Mode is the second operative mode of the BIT ONE. The most fundamental feature of the Double and Split mode is to allow you to have two different programs played simultaneously. In Double and Split mode you select and play a preset loaded on Lower prog. and another one Loaded on Upper prog. The volume balance of both is controlled by the relative volume sliders «Lower Volume and Upper Volume».

SPLIT MODE:

It allows to split the keyboard in any desired point in order to select a program in the left side and a second one on the right side of the keyboard.

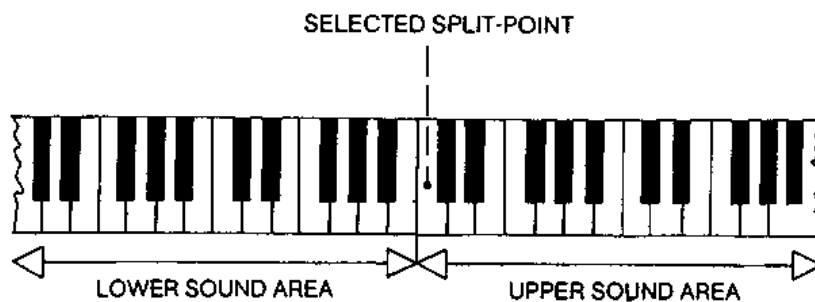

The six voices of the instrument will divide in the following way: 3 voices for the Lower sound (the ones set on the left side of the split point). 3 voices for the Upper sound (the ones set on the right side of the split point). Consequently the polyphony on each part of the keyboard will be of 3 voices, while the total polyphony will remain of 6 voices.

TO ACTIVATE THE SPLIT MODE PRESS THE SELECTOR «SPLIT»

How to Select the SPLIT point: having depressed the selector SPLIT, the first key you play on the keyboard will determine the split point (the key played will not produce any sound). Example: if you depress the C on the third octave (C3), the Lower sound will go from the C of the first octave to the C of the third octave (C1 - C3), while the Lower sound will go from C flat of the third octave to the C of the fifth octave (C flat 3 - C5). The key set as split point will always be the lower note of the sound selected for Upper prog.

SELECTION OF THE PROGRAMS LOWER AND UPPER

Once you set the Split point, you can select the programs Lower and Upper by depressing the relative selectors, and then composing the numbers of the desired programs on the numeric keyboard. You can change the programs any time by simply repeating the procedure of selection, for both Programmers. The Lower and Upper display will always indicate the last program loaded in the relative programmers, the one that you hear playing.

It is important to remember that the Lower sound will take place in the left side of the split point while the Upper sound will go in the right side.

Example:

OPERATION	Display Lower	Display Upper
Depress SPLIT selector		
Set Split point in C3		
Press LOWER selector		
Select number 12 (preset 12 loaded on Lower programmer)	12	—
Depress UPPER selector		
Select number 32 (preset n. 32 loaded on Upper programmer)	12	32
Select number 47 (change the sound on Upper programmer)	12	47
Depress LOWER selector	12	47
Select n. 4 (change the sound on Lower programmer)	4	47
Etc. etc.		

LOWER AND UPPER SELECTORS:

The Lower and Upper selectors as well as the Address selector (which we will see later on the section Editing), represent the «logic address» for the computer that controls the BIT ONE. Their function is to determine the address of the data introduced by the numeric keyboard.

The Lower selector, for example activates the address «program number for the Lower prog.». Consequently until the light of the Lower prog. selector will be on, all the data introduced by the numeric keyboard, will be interpreted as numbers of programs to be called from the sound memory and to be loaded on Lower prog. The same logic is valid for the address UPPER and ADDRESS. You can only activate one of these 3 selectors at time. Therefore if you are selecting a sound for the Lower prog. (Lower selector with led on), in order to select a sound on Upper prog., you have to depress the Upper selector (the led of Upper selector will light, automatically switching off the one on Lower selector) and then select the number of the desired preset on the numeric keyboard.

UNISON FUNCTION IN SPLIT MODE:

When you are in Split mode and you select Unison, both sounds Lower and Upper will become monophonic, summing up 3 voices each in the relative area of the keyboard.

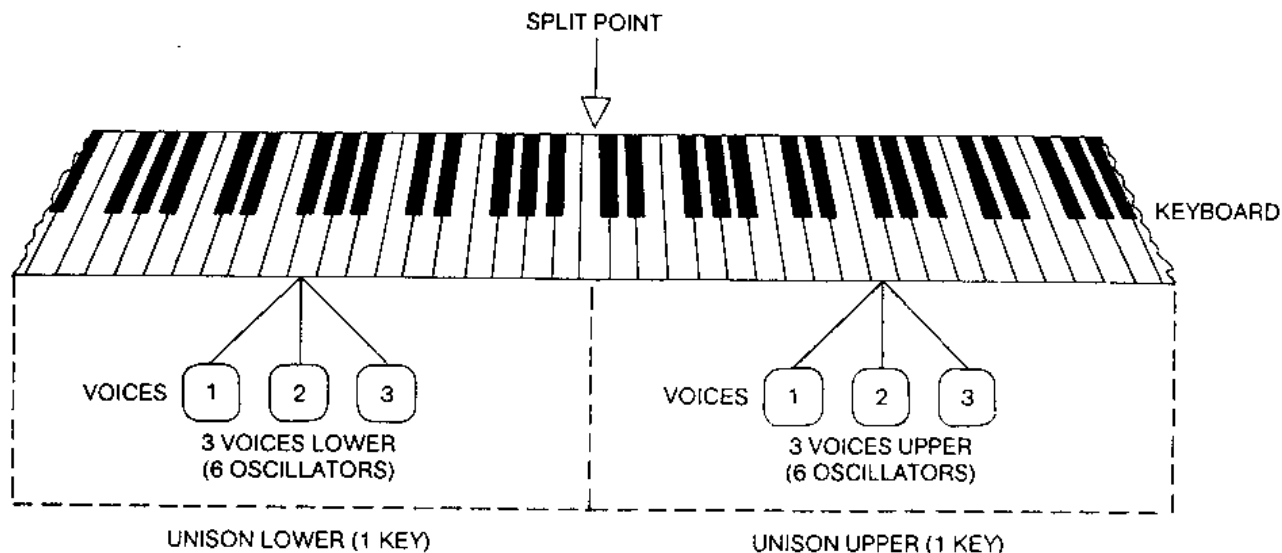

You obtain 2 Unison sounds with a maximum polyphony of two keys (one for the Lower side and another one for the Upper).

SPLIT MODE STEREO OUTPUT:

When you are in Split mode, from the audio outputs LOWER OUT and UPPER OUT will come out the sounds of the Lower and Upper programs, in order to utilize them in a stereo panorama or for an independent treatment of the two sounds.

DOUBLE MODE:

The Double Mode is the second bitimbric alternative of the BIT ONE.

In Double mode each key plays simultaneously both sounds of the Lower and Upper prog., laying two voices (one with Lower sound and one with Upper sound). The distribution of the voices of the instrument is the following: 3 for Upper sound, and 3 for Lower sound).

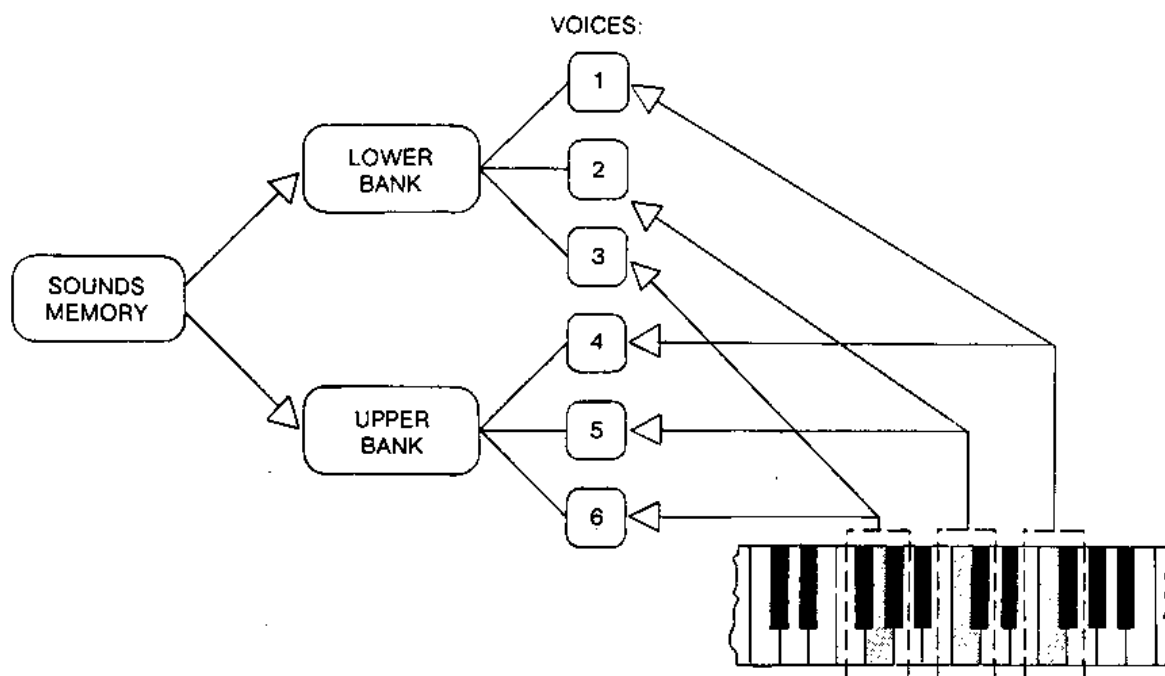

The Double mode will allow you to create very complex timbres, thanks to the capability to lay two sounds. The association of two sounds can be determined either by simply layering two effects already characterized (es. Brass + Piano, String + Brass) or by summing up two complementary sounds the result of which is the coupling of both.

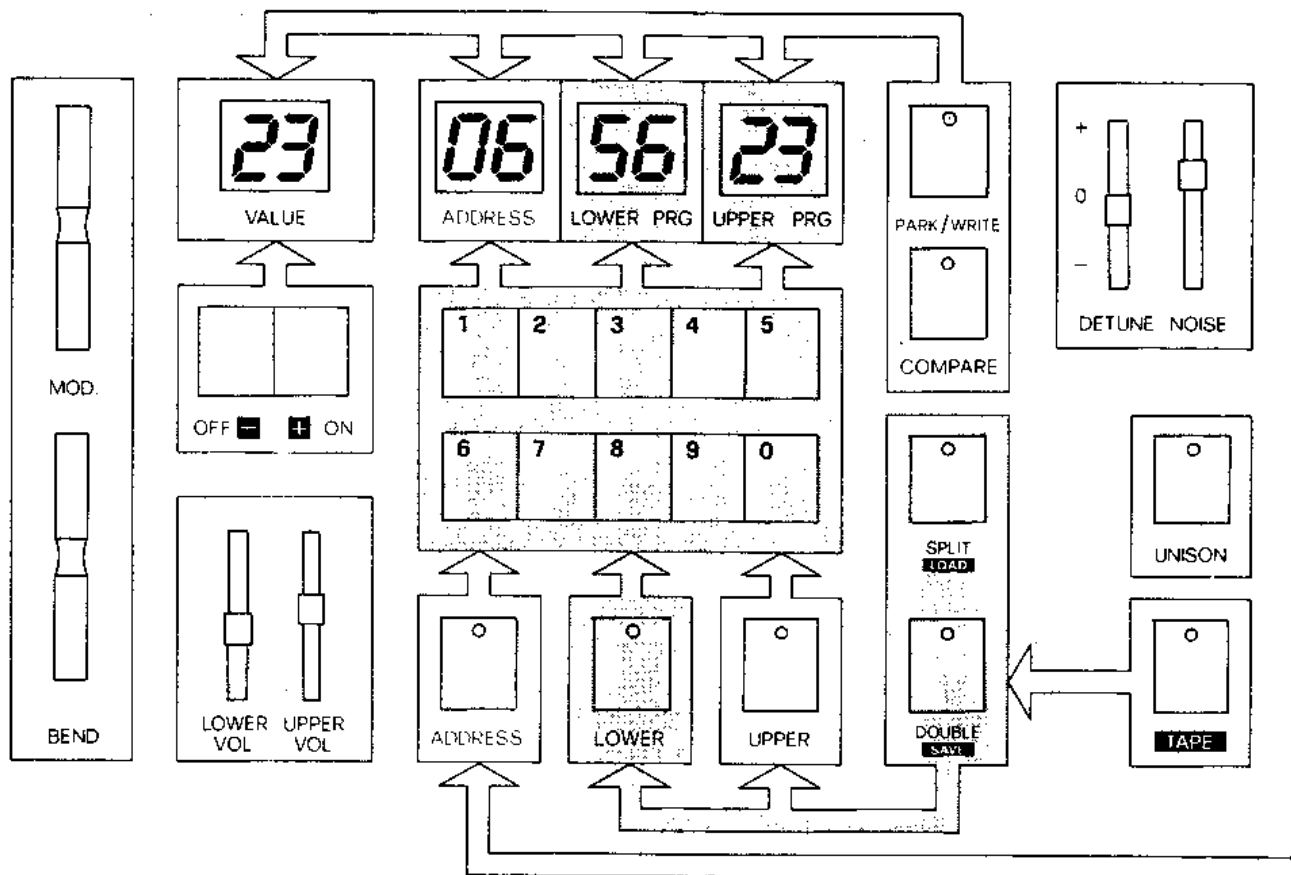

To activate the Double mode, switch on the selector Double. The programming logic of the Double mode is the same of the Split (the only difference is that you do not have to set the split point), and the Upper and Lower display will always indicate the last programs selected. In Double mode the maximum polyphony is 3 notes (six voices: two sounds = 3 notes with 2 sounds each). The Double function is very useful to create unusual effects. The availability of 4 oscillators for each key (2 from Lower sound and 2 from Upper) it already allows a certain degree of additive synthesis (feature found only on more expensive and complex systems).

When you disable the Double mode (by depressing the Double selector again), the Bit ONE will automatically return in Play mode with all six voices playing the preset selected on Lower Prog.

NOTE: any time you switch from Double to Play mode, it is necessary to set the Lower volume at max. in order to balance the six voices of the BIT ONE in Play mode.

DOUBLE MODE OF THE SAME SOUND:

While it does not have any meaning to select two identical sounds in Split mode, in Double mode instead is extremely interesting to sum up the same sound, loading it in the Lower and Upper Prog. It is true that you reduce the polyphony at 3 notes, but when it does not represent a problem, the result of the sound made by 4 oscillators is much richer and fatter.

DOUBLE MODE STEREO OUTPUT:

Like in Split mode from the Lower Output will come out the sound loaded in Lower Prog., and from Upper Output the one loaded in Upper Prog. The Stereo assignation will emphasize the coupling of the two sounds, moreover having independent outputs you can treat them separately (eg. Double between String with chorus effect and Brass straight).

UNISON:

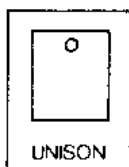

When the Unison selector is on, the BIT ONE becomes «biphonic». To each of the two keys is assigned 6 oscillators. In Play, Double and Split modes, the Unison function gives different results; described in the relative sections. The effect of 6 voices at Unison is a sound very rich and powerful, characterized by very light phasing between one and the other oscillators (detuning not between 2 but 6 oscillators).

BIT ONE: TOUCH SENSITIVITY

The keyboard of the BIT ONE is completely Touch sensitivity: it recognizes the velocity of any key played harder from those played softer. It is completely polyphonic. All parameters relative to touch sensitivity are programmable and therefore can be manipulated independently even between the Lower and Upper sounds (Split/Double modes).

Touch Sensitivity usually means the control of the Volume, but this is only one possibility offered by the BIT ONE, here is the others:

Attack and Envelope of V.C.F. = Timbre

Attack and Amount of V.C.A. = Volume

Pulse Width modulation of DCO1 & 2 = Waveform

Modulation Rate of LFO 1 & 2 = Modulation

In the «Editing» section, each of the touch sensitivity parameters will be explained in detail.

DYNAMIC SENSITIVITY CONTROL.

On the rear of the BIT ONE you will find a potentiometer «Dynamic Sens.» which control the general sensitivity of the dynamic range.

The function of this control is to increase or decrease electronically the response of the keyboard to your hands. You can make the response as light of as heavy as you want (it depends to what kind of technique you are used to) until you can achieve the widest dynamic range you can control.

BIT ONE: SOUND SYNTHESIS

A synthesizer is a set of electronic circuits put together to generate and manipulate electric oscillation, which driven into a speaker, will produce the sound. Each of these circuits is an «element» of the synthesizer. The configuration of these elements determines the structure of the instrument. From the block diagram you will see the element configuration of the BIT ONE.

Each voices of the BIT ONE includes:

- 2 DCO (Digital Controlled Oscillator)
- 1 VCF (Voltage Controlled Filter)
- 1 VCA (Voltage Controlled Amplifier)
- 2 LFO (Low Frequency Oscillator).

This structure has to be multiplied by 6: the voices available on the BIT ONE. Furthermore each of these voices will receive from the polyphonic keyboard all the information relative to a specific key played (key number), the beginning and the end of it (key on/off) and the dynamic range relative to that key.

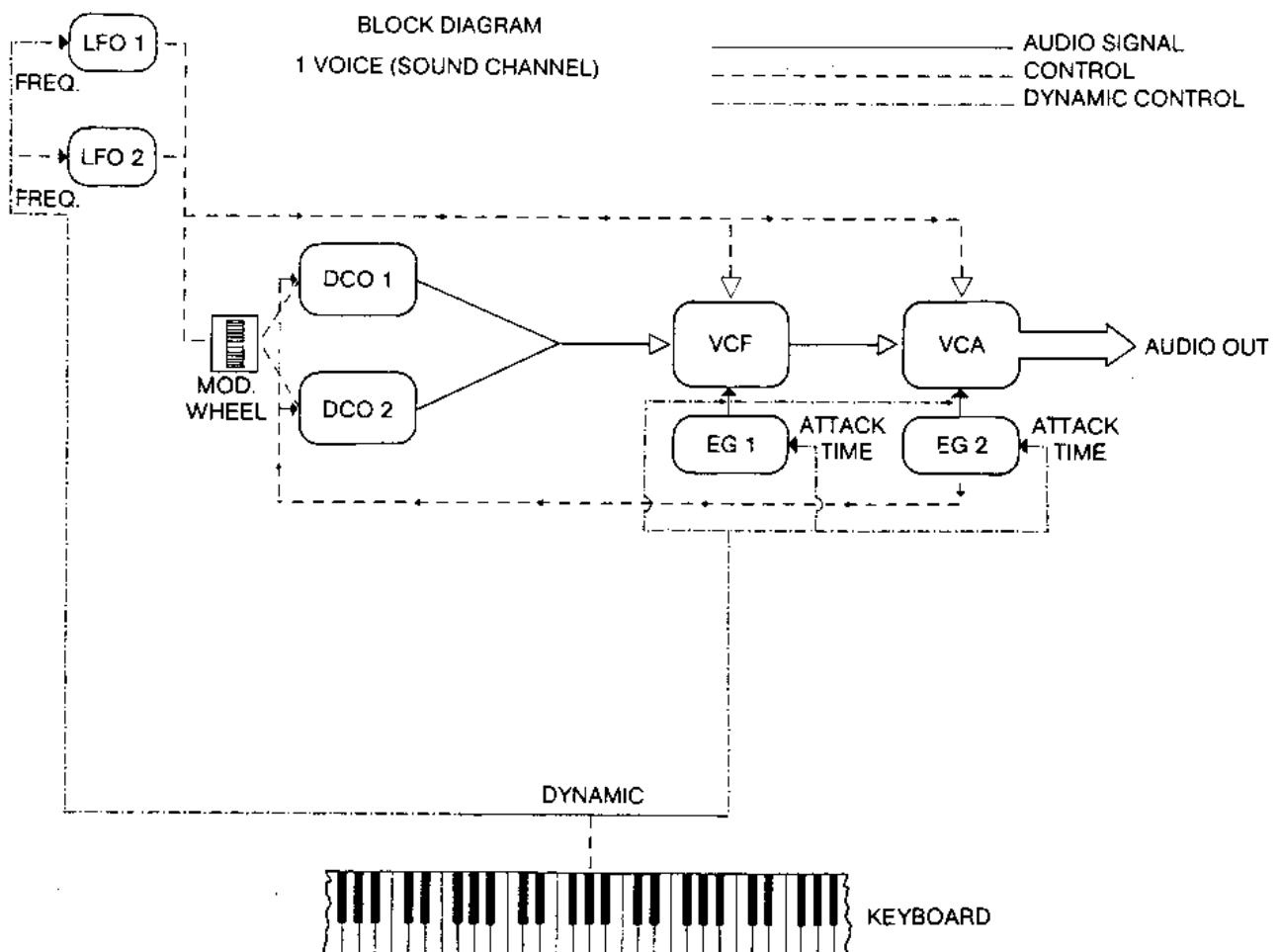

The elements that form each voice can be grouped in three families: Generation (Sources) - Manipulation (Modifiers) - Controllers.

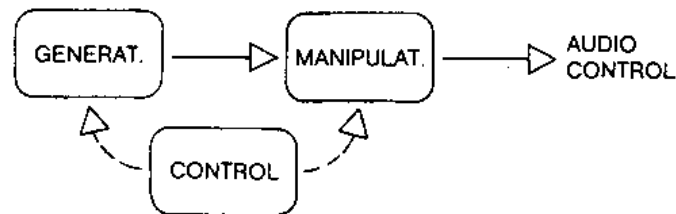

SOUND SOURCES: DCO1 DCO2 NOISE

They generate the audio signals which after being manipulated and amplified will become the sound. The basic sound «sources» used in the BIT ONE are 12 Digital Controlled Oscillators (DCO's) and also a Noise generator. The DCO's produce the actual pitches and the selected DCO Waveforms (and selection of footages: 16', 8', 4', 2') have a large effect on the tonal quality (timbre) of the sound.

MODIFIERS: VCF VCA

The sound modifiers for the BIT ONE are the Voltage Controlled Amplifier (VCA's) and the Voltage Controlled Filter (VCF's). The sound Modifiers take the unrefined sound produced by the DCO (sound source) and shape it into its final form, what you actually hear.

The VCF modifies the blend of overtones (and brightness) in the sound.

The VCA controls the change in Volume level which provide individual note articulation... how each note attacks, decays etc.

CONTROLLERS: EG1 EG2 LFO1 LFO2 Touch Sensitivity

The Sound controllers do not produce or modify any sound directly, they tell the sources and modifiers what to do. Without Controllers, there would be no way of coordinating the different modules in the synthesizer to produce useful sounds.

BIT ONE: EDIT MODE «Modification and creation of sounds»

To modify a sound means that you can alter the value of one or all parameters that determine it. The parameters are the controls of the various «elements» of the BIT ONE (DCOs - VCF - VCA - LFOs and Touch Sensitivity).

In the BIT ONE is always possible to modify or to create a new preset without losing the one you started with. It is possible to edit any of the 63 presets and then to memorize it:

1 - In place of the preset you started with, and therefore with the same program number.

2 - With a new program number, preserving the preset you started with. The Tape Interface will practically allow you to make an endless library of sounds.

THE CONTROLS OF THE BIT ONE

As you have already noticed the BIT ONE contains a very limited number of controls in respect of traditional synthesizer which are full of switches, knobs, deviators, potentiometers etc. With the BIT ONE you enter in a new and more updated dimension of a synthesizer's control panel: the solution of «MULTIFUNCTION MONOCONTROL».

An electronic potentiometer controlled by a numeric keyboard (0-9) will take care to all function whether it is a regulation of a certain parameter, or the introduction of a function or the selection of different possibilities etc. The electronic potentiometer – (off) and + (on) once it receives a code address relative to a certain function, it will control the regulation of that function, becoming for instance: once the selector of DCO's waveforms, once the control of the EG 1 Attack and so on...

How to recognize the codes relative to all possible functions.

Let's imagine to be over a city, the map of which is the one drawn on the panel of the BIT ONE. The residents of this city are all the various parameters of modification, all the various switches etc. The map of the city's controls is already divided in quarters, in other words in group of functions relative to the same section of the synthesizer:

Generation (Source) = DCO1 and DCO2

Manipulation (Modifiers) = VCF and VCA

Controllers = LFO 1, LFO2 and touch Sensitivity.

Each control's function «lives» at a precise address, represented by the number next to it, eg. Filter Cutoff = N. 18.

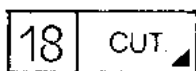

How can we control this or that function with our «MONOCONTROL»? Very simple: GIVING THE EXACT ADDRESS, by depressing the selector Address, and then composing the number of the function required.

Example:

We want to modify the Filter Cutoff of preset 19.

1 - Load on Lower Prog. preset 19.

2 - Depress selector Address.

3 - Compose on numeric keyboard 18 (address of parameter Cutoff).

4 - Regulate the parameter with selectors +/-.

It is possible to edit any parameter of the 63 presets simply by loading the preset on Lower Prog., depressing Address selector, and composing the number of the parameter required on the numeric keyboard.

EDIT MODE:

The address selector activates the EDIT MODE of a sound loaded in Lower Prog. and in Play Mode.

In Double and Split mode is not possible to edit a sound. In order to do that it is necessary to treat it singularly in Play Mode.

Once you have selected the number of the function to Edit, it will automatically appear on Display marked Address, while the Display marked Value will show you the current value of that parameter. The selector - (off) and + (on) will increase or decrease the current value like if you were using a potentiometer or a switch relative to the chosen function.

The modification of the value is immediate, it will appear on display «Value» and you can also hear it. If the function represent a potentiometer, the excursion will be in step from 0 to a certain value. If the function represent a switch, it will be 0 = Off — 1 = on. Untill the selector Address is on (Led lit) the editing operation can be made in sequences.

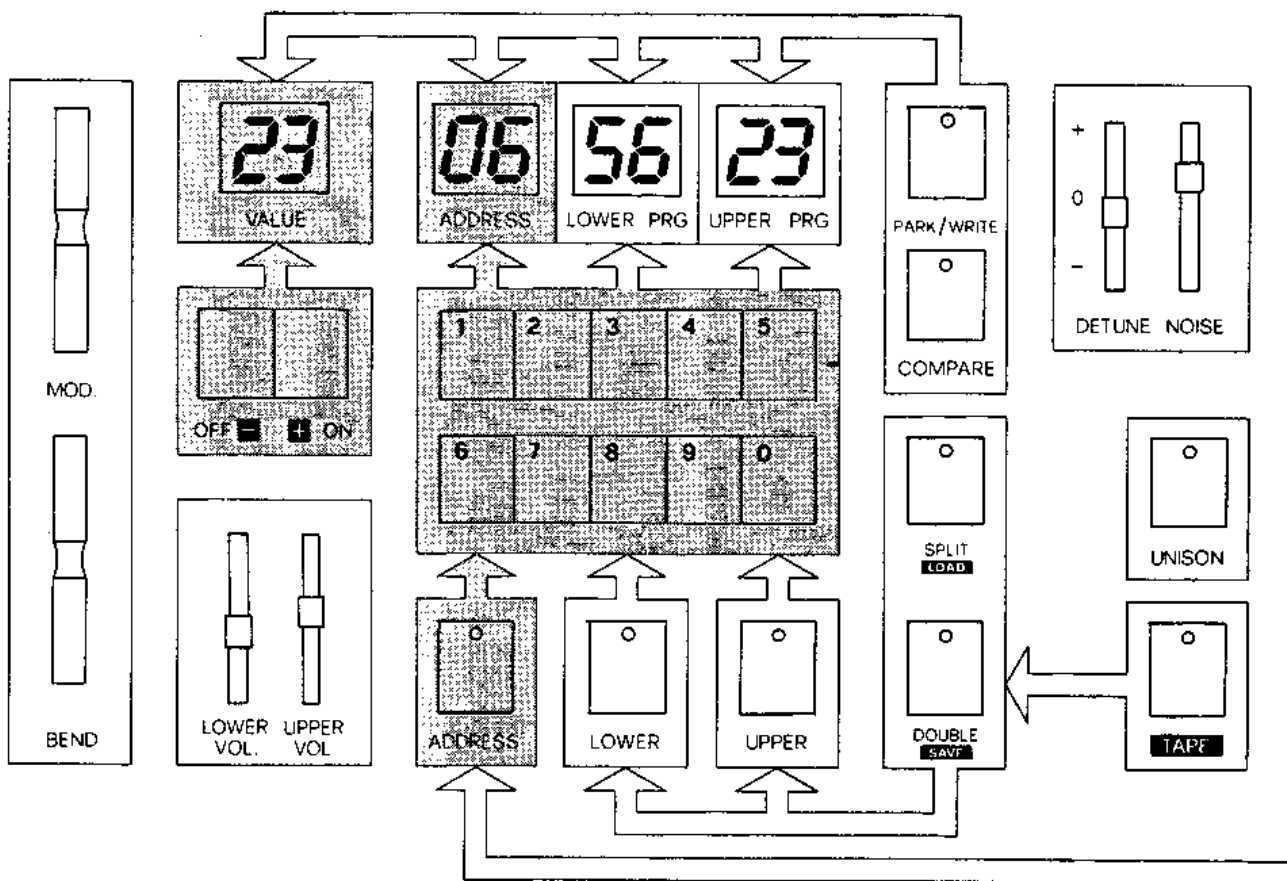

ADDRESS: it activates the Edit Mode and informs the computer that the data coming from numeric keyboard has to be interpreted as address number of the function to be modified.

DISPLAY ADDRESS: it shows the number of the selected parameter that you are working on.

DISPLAY VALUE: indicates the value of the parameter.

SELECTOR - (off) and + (on): They regulate the value.

NUMERIC KEYBOARD: It needs to «compose» the Address number of the chosen parameter.

The Edit Map will also inform you, beside the address number of a function, also what kind of control it represents. This is thanks to a symbolic representation.

POTENTIOMETER (0-XX) = triangle in the low right end side. 

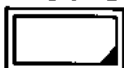
TOUCH SENSITIVITY PARAMETERS (0-XX) = outline rectangular with triangle in the low right end side. 

SWITCH (0-1) = no symbol. 

LFO 1 and LFO 2:

The Low Frequency Oscillators are used to modulate several section of the synthesizer.

Es: TRIANGULAR MODULATION → V.C.F. (CUT-OFF FREQUENCY)

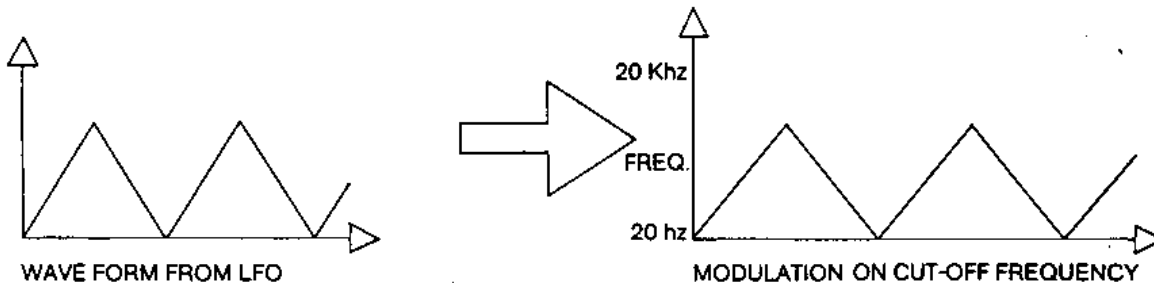

The LFOs are addressable to:
 VCF (Cut off frequency)
 VCA (volume)
 DCO 1 & DCO 2 (frequency).

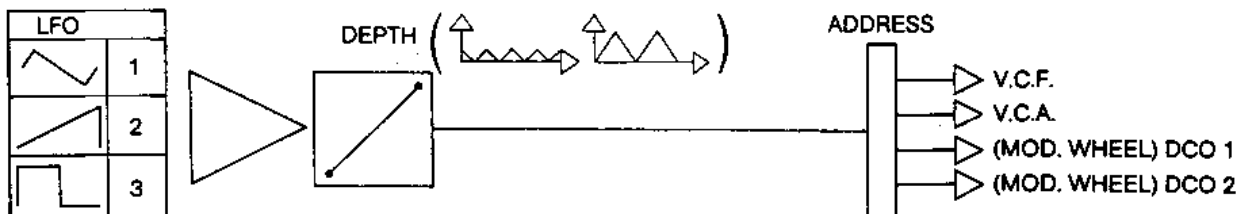

VCF = Timbric Modulation: it opens and closes the Filter.
 VCA = Volume Modulation: It raises and lowers the level of the sound.
 DCO 1 e 2 = Frequency Modulation of DCO 1 & 2 = Vibrato.

The modulation depth of DCO 1 and 2 is not determined only by the function «Depth», but also by the Mod. Wheel which become a second control to be used in real time, in order to vary the modulation from 0 to the value set on function «Depth». The extensive frequency range (0,2 - 250 Hz), unusual for LFOs, will allow you to have new timbric possibilities, obtainable thanks to the frequency modulation (F.M.) of the DCOs.

The LFOs are always triggered by the keyboard, and it always starts from the beginning of the modulation cycle when you depress the first key. The touch sensitivity control on LFOs (parameters 11 and 61) will allow you a direct frequency modulation by touch. The maximum dynamic range you will obtain is the one set on Rate control.

The functions 1 - 2 - 3 and 51 - 52 - 53 (waveforms selection for LFO 1 & LFO 2) cannot be summed up. If you choose the Triangle for instance, it will automatically cancel the Sawtooth and Square of the same group.

EDIT MAP: ACCESSIBLE FUNCTIONS.

Please note: sw = Switch — pt = potentiometer

L.F.O. 1

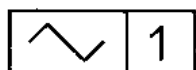

TRIANGULAR

sw. (0 = off – 1 = on)

It assigns the Triangular waveform to LFO 1

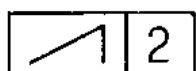

SAWTOOTH

sw. (0 = off – 1 = on)

It assigns the Sawtooth waveform to LFO 1

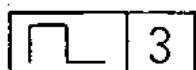

SQUARE

sw. (0 = off – 1 = on)

It assigns the Square waveform to LFO 1

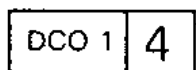

LFO 1 to DCO1

sw. (0 = off – 1 = on)

It address the LFO 1 to modulate in frequency the DCO 1

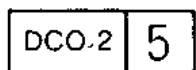

LFO 1 to DCO2

sw. (0 = off – 1 = on)

It address the LFO 1 to modulate in frequency the DCO 2

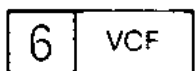

LFO 1 to VCF

sw. (0 = off – 1 = on)

It address the LFO 1 to modulate the Cutoff frequency of VCF

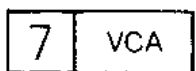

LFO 1 to VCA

sw. (0 = off – 1 = on)

It address the LFO 1 to modulate the Amount of VCA.

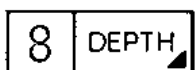

LFO 1 MODULATION DEPTH

PT. (0 to 63)

It regulates the modulation depth of LFO 1 of the choosed address. The modulation depth of DCO 1 & 2 is also controlled by the Mod. Wheel.

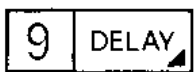

LFO 1 MODULATION DELAY

PT. (0 to 63)

It regulates the delay time from the moment you depress the key and the introduction of the momdulation, it will be introduced gradually from zero to the value setted on Depth (n. 8).

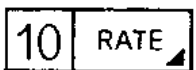

LFO 1 RATE

PT. (0 to 63)

It regulates from 0,5 to 250 Hz. the frequency of LFO 1, in other words the velocity of the modulation cycle.



DYNAMIC TO LFO 1 RATE

PT. (0 to 63)

It regulates the LFO 1 Rate by touch sensitivity.

L.F.O. 2

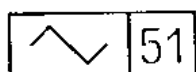

51

TRIANGULAR

sw. (0 = off - 1 = on)

It assigns the Triangular waveform to LFO 2

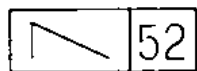

52

SAWTOOTH

sw. (0 = off - 1 = on)

It assigns the Sawtooth waveform to LFO 2

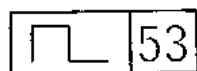

53

SQUARE

sw. (0 = off - 1 = on)

It assigns the Square waveform to LFO 2

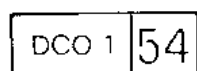

54

LFO 2 to DCO1

sw. (0 = off - 1 = on)

It address the LFO 2 to modulate in frequency the DCO 1.

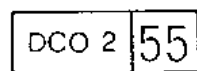

55

LFO 2 to DCO2

sw. (0 = off - 1 = on)

It address the LFO 2 to modulate in frequency the DCO 2

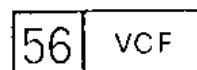

VCF

LFO 1 to VCF

sw. (0 = off - 1 = on)

It address the LFO 2 to modulate the Cutoff frequency of VCF

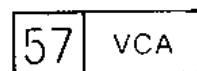

VCA

LFO 1 to VCA

sw. (0 = off - 1 = on)

It address the LFO 2 to modulate the Amount of VCA.

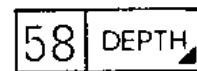

DEPTH

LFO 2 MODULATION DEPTH

PT. (0 to 63)

It regulates the modulation depth of LFO 2 of the chosen address. The modulation Depth of DCO 1 & 2 is also controlled by the Mod. Wheel.

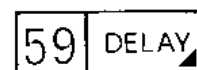

DELAY

LFO 2 MODULATION DELAY

PT. (0 to 63)

It regulates the delay time from the moment you depress the key and the introduction of the modulation, it will be introduced gradually from zero to the value setted on Depth (n. 58).

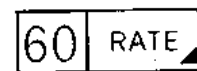

RATE

LFO 2 RATE

PT. (0 to 63)

It regulates from 0,5 to 250 Hz. the frequency of LFO 2, in other words the velocity of the modulation cycle.

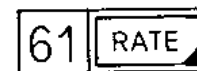

RATE

DYNAMIC TO LFO 2 RATE

PT. (0 to 63)

It regulates the LFO 2 Rate by touch sensitivity.

ENVELOPE GENERATORS AND VCF

The functions 12 / 13 / 14 / 15 are the 4 A.D.S.R. controls of EG 1 which is always assigned to Cutoff Frequency of VCF.

VCF

The Voltage Controlled Filter (VCF) controls tonal quality (timbre) by selectively removing and emphasizing different overtones of the DCOs waveforms. The VCF used in the BIT ONE are a Lowpass - Band-pass filters: it passes overtones **BELOW** the Cutoff Frequency and reduces or removes completely the overtones **ABOVE** the Cutoff Frequency.

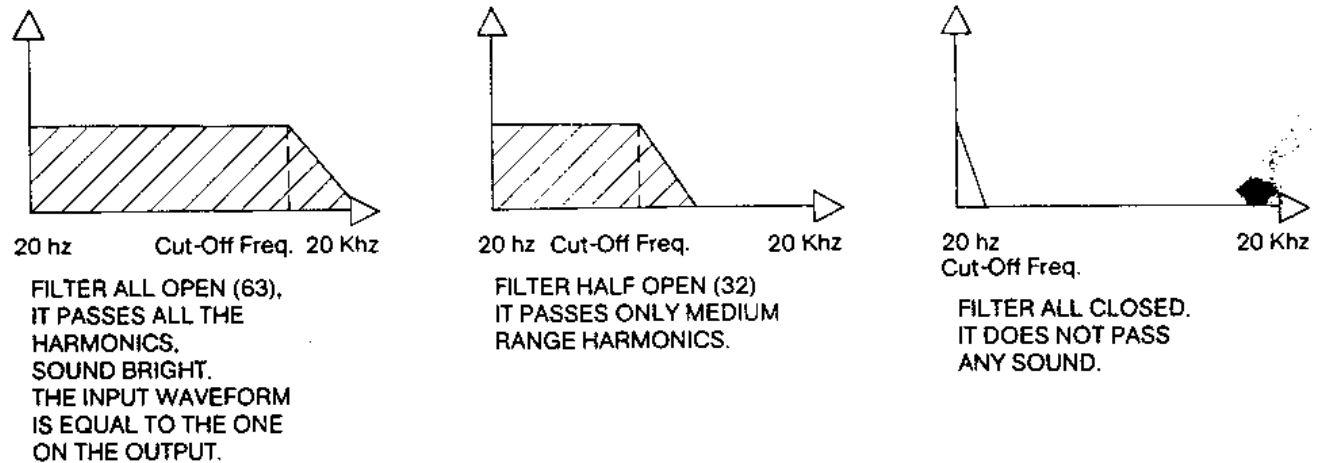

RESONANCE: the Resonance emphasizes the harmonics near the Cut-off frequency, producing a characteristic «wah» or «band pass» type of sounds.

THE ENVELOPE GENERATOR

The EG 1 is a voltage controlled generator that moves the Cutoff Frequency of the VCF proportionally to the movement of its voltage's control, this is definable in the time by a cycle that includes 4 stages: 1 (ATTACK) - 2 (DECAY) - 3 (SUSTAIN) - 4 (RELEASE).

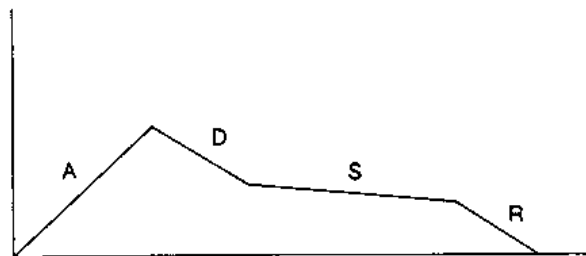

A = Attack time: controls how long it takes for the envelope contour to rise from zero to its max level after the key is depressed.

For VCF corresponds to an opening of the filter from a dull to bright sound. For VCA (EG 2) corresponds to a rise of the Volume from 0 to max. The Attack begins when you depress a key.

D = Decay Time: determines the rate at which the envelope contour falls from the maximum (Attack) level to the Sustain level.

For VCF corresponds to a closing of the filter from a dull to a bright sound. For VCA (EG 2) corresponds to a fall of the Volume from max. to Sustain level.

S = Sustain time: determines the constant envelope level at which the sound is sustained after the Attack and Decay phases are completed, for as long as the key is kept depressed. If the Sustain is 0 the Decay tends to 0. For VCF corresponds to a fixed Cutoff Frequency. For VCA corresponds to a fixed level of Volume.

R = Release time: determines the rate at which the envelope contour falls from the Sustain level to zero after the key is released. For VCF corresponds to a closing from bright to dull. For VCA corresponds to a fall of the Volume to zero.

The use of the EGs is fundamental in order to define the characteristic of «percussivity, softness, depth etc» of a sound.

TOUCH SENSITIVITY to EG 1 DEPTH of VCF

The dynamic touch that controls the modulation depth of EG 1 to VCF allows spectacular effects and expressive possibilities. The timbre changes according to the strength you depressed a key. When you want to control with-dynamics the max. timbre excursion, we suggest to keep the Cutoff Frequency control all close (0), and the dynamic ENV control (N. 21) all open.

- A** 12 ATTACK TIME
pt. (0 to 63)
- D** 13 DECAY TIME
pt. (0 to 63)
It regulates the Decay time of the EG 1.
- S** 14 SUSTAIN LEVEL
pt. (0 to 63)
It regulates the Sustain level of the EG 1.
- R** 15 RELEASE LEVEL
pt. (0 to 63)
It regulates the Release time of the EG 1.
- TRACK** 16 KEYBOARD TRACKING
pt. (0-63)
Keyboard Tracking controls how the VCF Cutoff frequency changes as you play up and down the keyboard. It needs to have a Filter equality both in the lower and in the higher notes.
0 = NO tracking - 22 = +/- 1 volt per octave -63 = +/- 3 volt per octave.
- 17** **A** ATTACK TIME EG 1 WITH DYNAMICS
pt. (0 to 63)
It regulates the dynamic on the Attack time by touch. - (soft) = slow Attack time.
+ (hard) = Fast Attack until zero.
- 18** **CUT.** CUT-OFF FREQUENCY
pt. (0 to 63)
It regulates from 0 to 20 Hz. the cutoff frequency of the VCF.
0 = filter all closed
63 = filter all open: it pass all audible frequencies.
- 19** **RES.** RESONANCE
pt. (0 to 63)
It emphasizes the harmonics near the cutoff frequency. The higher the value, the stronger the effect on the filter (timbre). The Resonance can produce typical synthesizer «wah-wah» sounds, it helps to make instrumental sounds more realistic, and generally a good variety of subtle and dramatic effects.

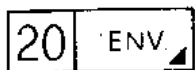
**EG DEPTH to VCF**

pt. (0 to 63)

It regulates the modulation Depth of the Cutoff Frequency affected by EG 1. It determinates how much the EG1 voltage control «moves» the Cutoff Frequency.

**DYNAMIC to EG 1 DEPTH of VCF**

pt. (0 to 63)

It regulates by touch, the dynamic on modulation Depth of VCF when influenced by the EG 1. When this control is setted at max. (63), and you play with max. strength, the level of VCF modulation Depth affected by the EG 1 you obtain, is the one setted on control ENV. (n. 20).

– (soft) = filter closed, dull sound. + (hard) = filter open, bright sound

It is obvious that in order to hear the dynamic response on the Filter you have «to open» also the control ENV. (n. 20).

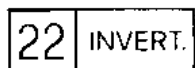
**EG 1 POLARITY INVERTER**

sw. (0 = off – 1 = on)

It inverts the polarity of the EG 1 when it-influences the VCF.

DCOs (Digital Controlled Oscillators)

The basic sounds sources on the BIT ONE are the 12 Digitally Controlled Oscillators (6 for DCO 1 and 6 for DCO 2), which offer precise frequency tuning and stability through the use of advanced integrated digital technology. The BIT ONE DCOs operate on a principle of additive squarewave synthesis which digitally produces 3 elementary waveforms: Triangular - Sawtooth and variable Pulse. Each waveform is characterized by a particular harmonics contents, in other words different basic timbre.



= TRIANGULAR = Sound with less harmonics and simpler than Sawtooth.



= SAWTOOTH = Trumpet, Brass, Strings Orchestral sounds. Sound rich with body, lightly nasal but bright.



= Variable Pulse = different harmonics contents according to the width. At 50% = Square wave (Clarinet, Metal, Pipe, metallic percussion). From 50% to 3% = different harmonic contents.

The tuning controls allow to move independently the frequency of DCO 1 and 2 by octave (32"/16"/8"/4") and also by semitones of an octave (FREQ. N. 31 and 42). The waveforms can be selected simultaneously (n. 27/28/29 and 38/39/40) while the octaves cannot be summed up. Naturally between the two DCO is possible to have different octaves.

D.C.O. 1 Edit Map's functions

23 32' 32" FOOT
sw. (0 = off - 1 = on)

24 16' 16" FOOT
sw. (0 = off - 1 = on)

25 8' 8" FOOT
sw. (0 = off - 1 = on)

26 4' 4" FOOT
sw. (0 = off - 1 = on)

They select the octave for DCO 1 in a range of 4 octave.

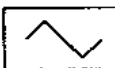
 27 TRIANGLE
sw. (0 = off - 1 = on)
It selects the Triangle waveform for DCO 1.

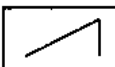
 28 SAWTOOTH
sw. (0 = off - 1 = on)
It selects the Sawtooth waveform for DCO 1.

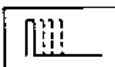
 29 VARIABLE PULSE
sw. (0 = off - 1 = on)
It selects the variable Pulse waveform for DCO 1 (it include also the Square waveform).

30 ADSR EG 2 to DCO 1 FREQUENCY
sw. (0 = off - 1 = on)
It addresses the voltage control of EG 2 (VCA) to the control of the DCO 1 frequency, allowing a tuning shift according to the movement of the EG 2.

31 FREQ FREQUENCY RANGE
PT. (0 to 13)
It raises the frequency of DCO 1 in step of 1/2 tone, up to a max range of an octave (step 13).

32 PW PULSE WIDTH
pt. (0 to 31)
It regulates the width of the Pulse waveform generated by DCO 1. The Width is measured as a percentage between positive and negative phase of the cycle.
0 = 3% ——— 16 = 50% ——— 30 = 97%

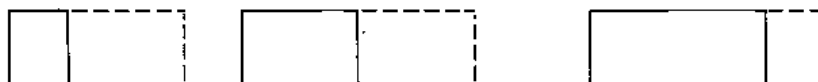

The Pulse at 50% is a Square waveform.
For each Width value between 3 and 50%, the Pulse has different harmonics contents, and therefore different timbres.
Narrow Pulse = 3% = sound very nasal (oboe)
Narrow Pulse = 10% = clarinet, guitar, sitar
Narrow Pulse = 20% = electric bass, guitar, percussive string instrument.

33 PW

DYNAMIC to PULSE WIDTH

pt. (0 to 63)

It regulates the presence of dynamic on Pulse width. The result you obtain is very much dependent to the value setted on parameter P.W. 32 which determines the max. value of the width obtainable with the highest velocity you depress the keys.

P.W. 32 determines where it arrives with the max. velocity of your hands.

P.W. 33 determines from where it starts with the minimum velocity.

The dynamic control of the Pulse Width will allow you to vary by touch the waveform and the harmonics contents of the sound.

D.C.O. 2 Edit Map's functions

34 32'

32" FOOT

sw. (0 = off - 1 = on)

35 16'

16" FOOT

sw. (0 = off - 1 = on)

36 8'

8" FOOT

sw. (0 = off - 1 = on)

37 4'

4" FOOT

sw. (0 = off - 1 = on)

They select the octave for DCO 2 in a range of 4 octave.

 38

TRIANGLE

sw. (0 = off - 1 = on)

It selects the Triangle waveform for DCO 2.

 39

SAWTOOTH

sw. (0 = off - 1 = on)

It selects the Sawtooth waveform for DCO 2.

 40

VARIABLE PULSE

sw. (0 = off - 1 = on)

It selects the variable Pulse waveform for DCO 2 (it includes also the Square waveform).

41 ADSR

EG 2 to DCO 2 FREQUENCY

sw. (0 = off - 1 = on)

It addresses the voltage control of EG 2 (VCA) to the control of the DCO 2 frequency, allowing a tuning shift according to the movement of the EG 2.

42 FREQ.

FREQUENCY RANGE

PT. (0 to 13)

It rises the frequency of DCO 2 in step of 1/2 tone, up to a max excursion of an octave (step 13).

43 PW

PULSE WIDTH

pt. (0 to 30)

It regulates the width of the Pulse waveform generated by DCO 2. The Width is measured as a percentage between positive and negative phase of the cycle.

0 = 3% ——— 16 = 50% ——— 30 = 97%

The Pulse at 50% is a Square waveform.

For each Width value between 3 and 50%, the Pulse has different harmonics contents, and therefore different timbres.

Narrow pulse = 3% = sound very nasal (oboe)

Narrow Pulse = 10% = clavinet, guitar, sitar

Narrow Pulse = 20% = electric bass, guitar, percussive string instrument.

44 PW

DYNAMIC to PULSE WIDTH

pt. (0 to 63)

It regulates the presence of dynamics on Pulse width. The result you obtain is very much dependent to the value setted on parameter P.W. 43 which determines the max. value of the width obtainable with the highest velocity you depress the keys. P.W. 43 determines where it arrives with the max. velocity of your hands. P.W. 44 determines from where it starts with the minimum velocity. The dynamic control of the Pulse Width will allow you to vary by touch the waveform and the harmonics contents of the sound.

V.C.A.

A 45

DYNAMICS TO ATTACK TIME OF VCA's EG 2

pt. (0 to 63)

Like the parameter 17 (dynamic attack EG 1 of VCF), it regulates the control from the dynamic of the Attack time of EG 2.

– (play soft) = slow Attack time.

+ (play hard) = fast Attack time untill zero.

With this control you can determine by touch a Slow or Fast Attack, it is very usefull for orchestral effects.

AMT 46

DYNAMICS TO VCF AMOUNT

pt. (0 to 63)

It allows to control the Volume of a sound by touch.

47 A

ATTACK TIME OF EG 2

pt. (0 to 63)

It regulates the Attack time of EG 2

48 D

DECAY TIME OF EG 2

pt. (0 to 63)

It regulates the Decay time of EG 2.

49 S

SUSTAIN LEVEL OF EG 2

pt. (0 to 63)

It regulates the Sustain level of EG 2.

50 R

RELEASE TIME OF EG 2

pt. (0 to 63)

It regulates the Release time of EG 2.

All the editing operations made on the sound are memorized only on the working memory of the BIT ONE, and not on the presets memory.

This will allow you to come back any time you want to the original preset, however it also allow you to immediately memorize any edited sound like any one of the 63 presets (refer to chapter «writing the programs»).

If during the editing you recall a preset on lower prog. by mistake, all the editing operations made will be cancelled.

for comparison between edited and original sounds, use the very convenience function «Compare» described in chapter «WRITING THE PROGRAMS».

HOW TO WRITE PROGRAMS IN THE MEMORY

The sound memory of the BIT ONE can store 63 sounds (01 to 63).

For each sound is remembered all the values of the parameters accessible during the Editing. Each of the 63 presets located in the memory can be always modified and rememorized. Furthermore the entire sounds memory can be transferred in a tape or loaded from a tape by the use of the Tape Interface. The sounds memory is powered by a back up battery which insure the functioning of the memory when the instrument is switched off. This battery has a life time of about 3 years.

WRITING PROGRAMS IN THE MEMORY PROCEDURE:

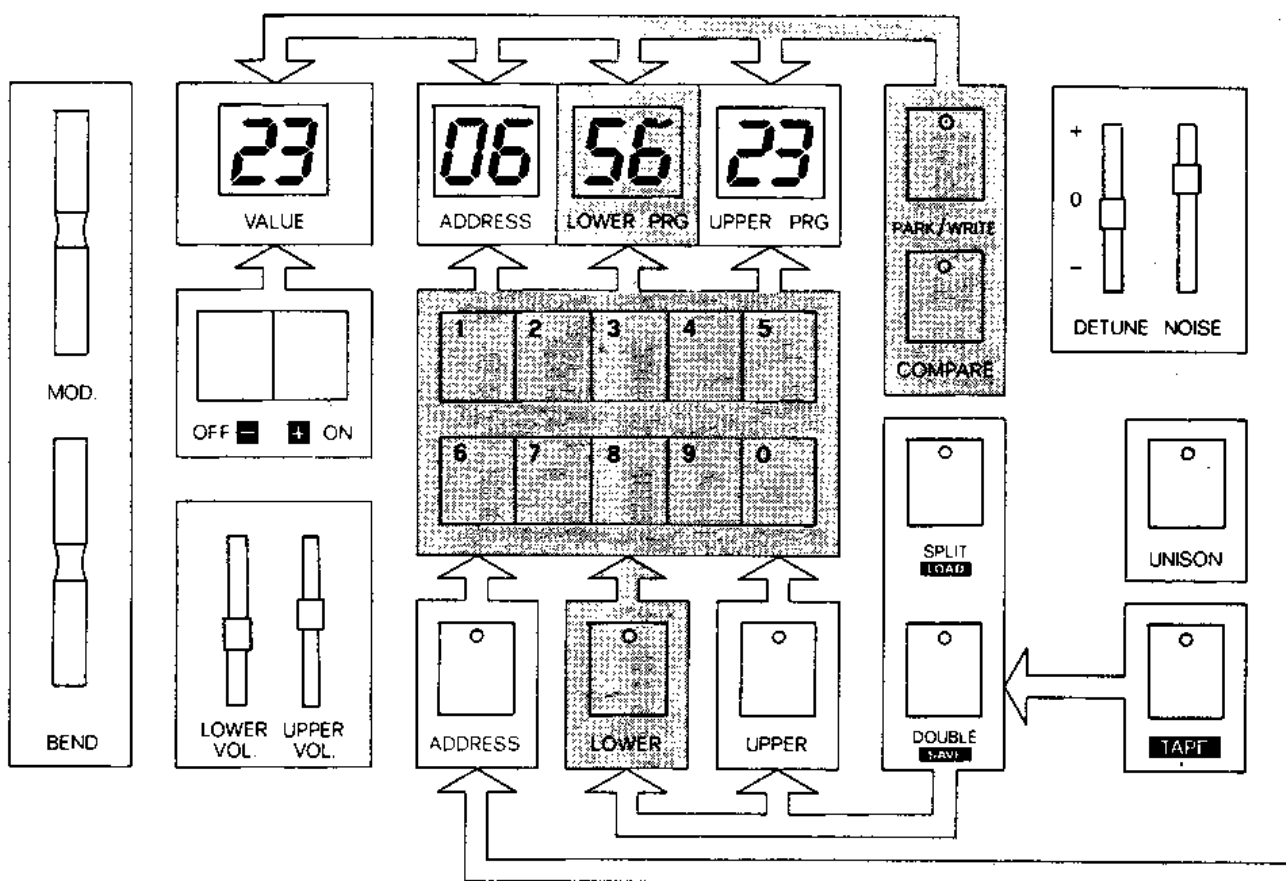

It is possible to write a sound starting with the following 2 different situation:

- 1 - After an Editing operation.
- 2 - In Play Mode when you have to organize the memory of the 63 presets already «made».

It is not possible to write programs in the memory if you are in Double or Split mode.

To write a sound in the memory you have to use the selector Park/Write. A sound can be written only if it is loaded on Lower Prog.

The selector Park/Write has two functions: by depressing it one time (Led lit) you send the sound on a parking area, which is completely independent from the sound memory. The sound parked will be saved from any other loading operation you are going to do on the Lower Prog. When you depress the selector again (Led off), the parked sound will be written in the memory location number indicated on the display Lower Prog.

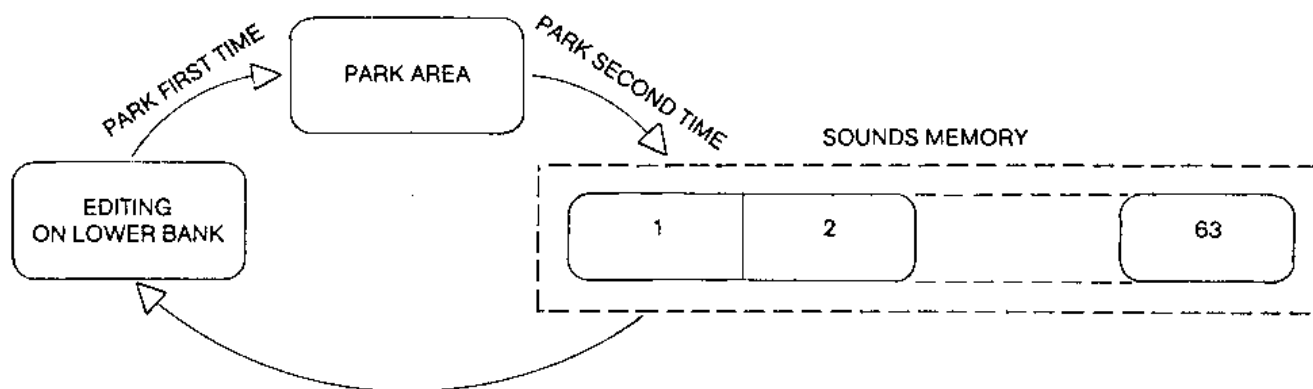

HOW TO WRITE A SOUND ON THE SAME PROGRAM NUMBER:

- 1 - Load the sound in Play Mode on Lower Prog.
 - 2 - Edit it until you find the wanted result.
 - 3 - Depress Park/Write selector once (Led lit).
 - 4 - Load on Lower Prog. the number of the preset that you want to cancel, hear it, if it is OK, depress Park/Write selector again (Led off) and then the sound that you had parked will be written in that memory location.
- If you are not sure of the preset to cancel, before depressing Park/Write selector for the second time, just continue to load the presets on Lower Prog. until you find the one to substitute.

PROTECTION OF THE SOUND MEMORY:

In order to safeguard the presets in the memory, the memory of the BIT ONE has a protection switch marked «Memory protect» situated on the rear panel.

If this switch is in position «ON» it is not possible to write sounds, furthermore the Led of the selector Park/Write will never light.

THE FUNCTION COMPARE

The selector Compare is very useful either during the writing of sounds than when you are Editing or in Play mode.

When you are writing a sound the selector Compare will let you come out from Park/Write mode, if you decide to stop writing the sound.

In Edit mode instead it will let you have a quick comparison between the sound you are editing and the one you have started with.

Example:

- 1 - Load a sound on Lower Prog.
- 2 - Depress Park (LED on) than depress compare (LED Park off)
- 3 - Edit it until you achieve the wanted result.
- 4 - Depress Compare (The display address and Address Value will switch off).
- 5 - Depress Compare again and hear the edited sound.
- 6 - Modify the sound if necessary (by depressing address plus the number of the function from the Edit Map).
- 7 - Depress Compare again and you will hear the sound you started with... etc.

If after the use of the «Compare» you want to procede to write the sound, keep in mind that the sound will first go in Park and then in Write.

REAR PANEL

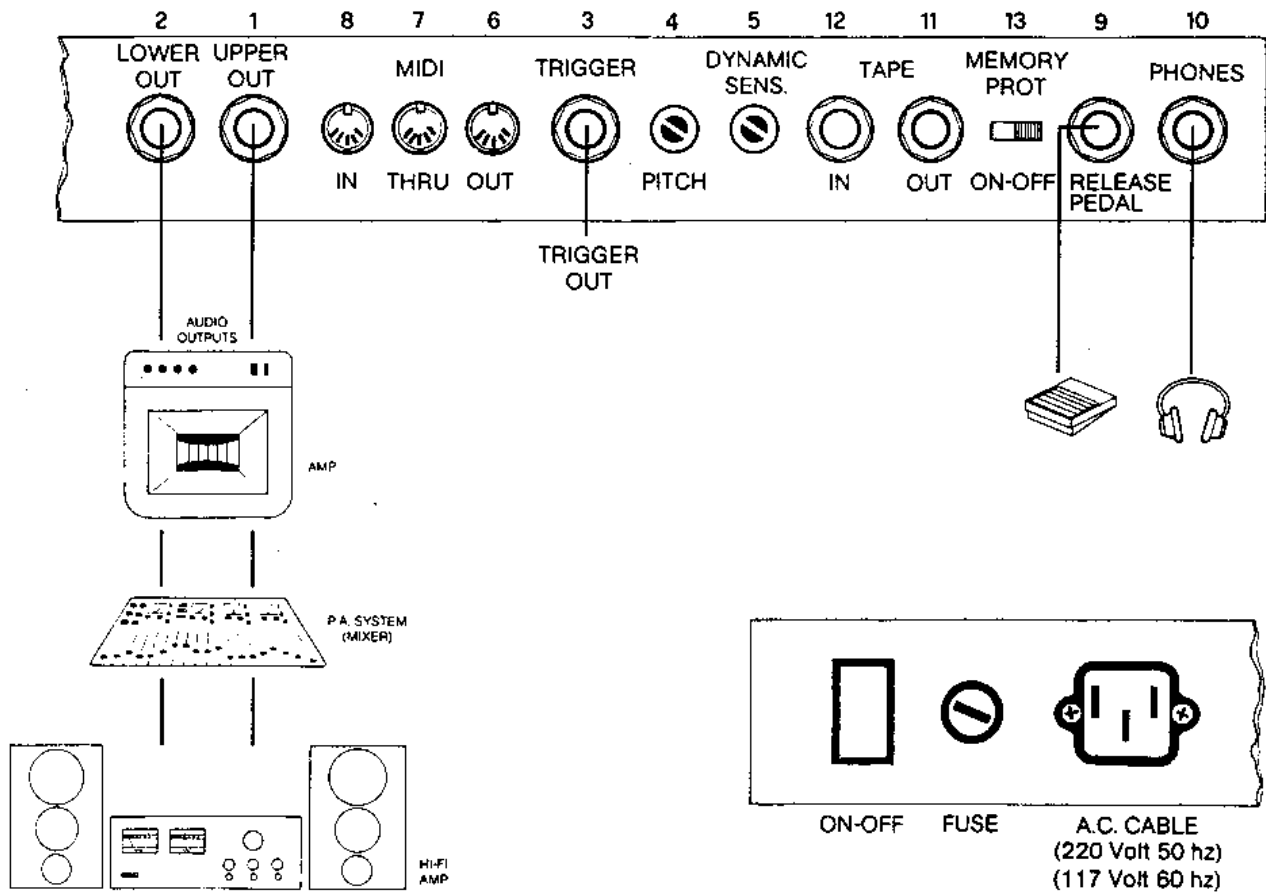

- 1) UPPER/MAIN AUDIO OUT: audio output of lower and upper voices
- 2) LOWER AUDIO OUT: audio output lower voices
- 3) TRIGGER OUT: trigger out (for each key played) pulse – 20 ms
- 4) GENERAL PITCH: $\pm 1/2$ tone.
- 5) DYNAMIC SENSITIVITY.
- 6) MIDI OUT.
- 7) MIDI THRU.
- 8) MIDI IN.
- 9) RELEASE PEDAL (it activates the Release when depressed of about 8 sec.)
- 10) PHONE OUTPUT.
- 11) TAPE OUT.
- 12) TAPE IN.
- 13) MEMORY PROTECT SWITCH (protection for sound memory).

TAPE INTERFACE

The Tape Interface lets you save the contents of the Program Memory data onto a cassette tape. Thanks to the Tape Interface it is possible to accomplish a large library of sounds, ready to be loaded in the BIT ONE in short time. The Tape Interface includes the selector TAPE, LOAD and SAVE on the front panel and two outputs «Tape In» and «Tape Out» on the rear panel.

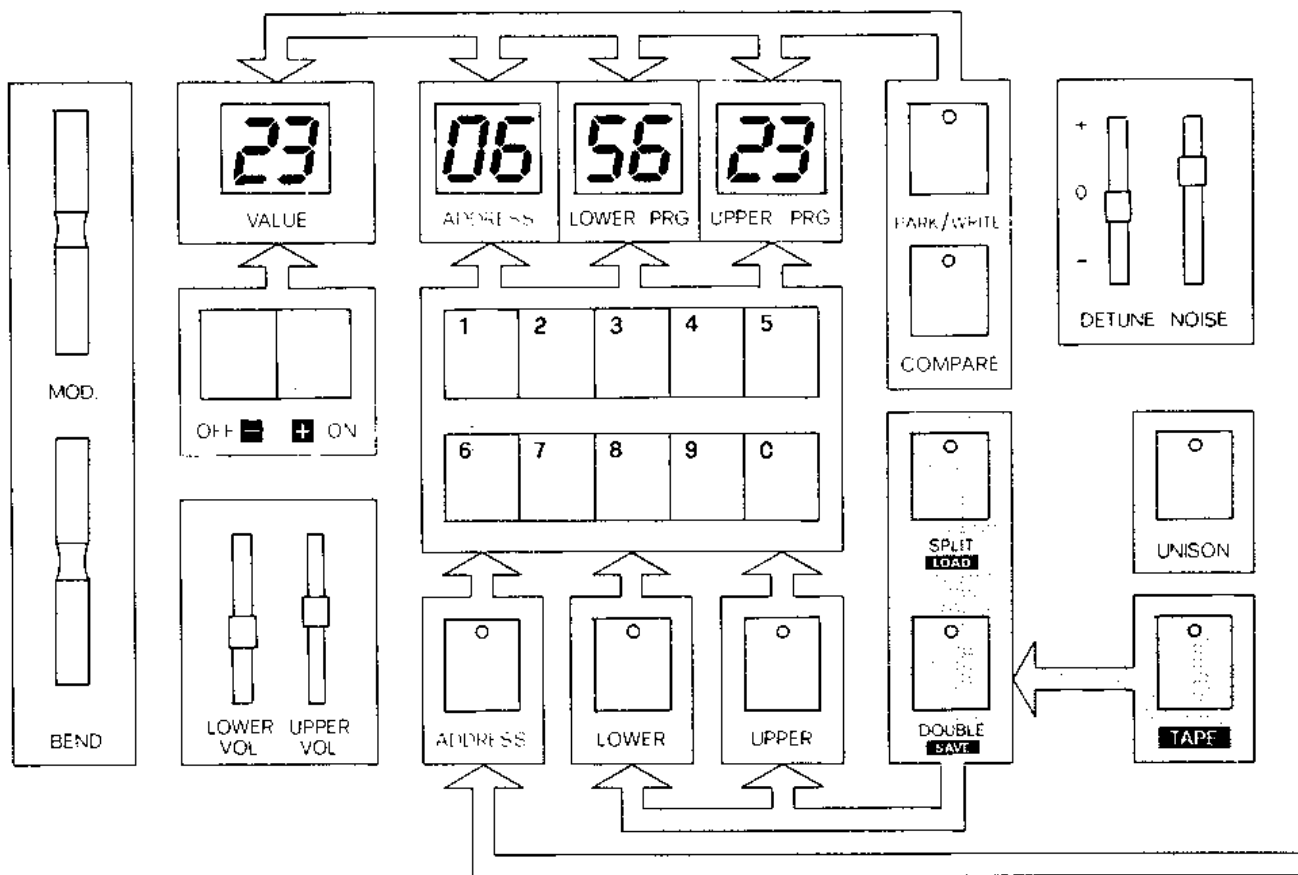

TAPE MODE:

The Tape mode is the last operative mode of the BIT ONE. The Tape mode is operative when you depress the selector TAPE (Led lit). The Tape mode cancels all the other functions, and it activates the second function of the selectors SPLIT and DOUBLE which become Split = Load and Double = Save.

Once you depress the selector Tape (Led lit) the BIT ONE is ready to receive or transmit all the data relative to its sound memory.

The BIT ONE Tape Interface is designed to be used with medium to good quality tape recorders and tape cassette, low quality tape cassette brands will generally causes problems, and «walk-man» type recorders and micro cassette units may not have a sufficiently high output level.

HOW TO CONNECT THE TAPE RECORDER:

The output Tape Out goes to input Line IN (Aux IN/Mic IN/Record IN) of the tape recorder. The Input Tape In goes to output Line Out (Aux Out/Phone Out/Play) of the tape recorder.

If the tape recorder is stereo, it is much better to record simultaneously in Mono on both channels, in order to have an extra channel, when you will load from Tape.

It is important to exclude all possible Noise Reduction Systems like Dolby, A.B.C., MPX filters etc.

SAVING PROGRAM DATA ON TAPE:

1. - CONTROL OF THE LEVELS

- a) Depress Tape Selector (Led Lit).
- b) Set the tape recorder on «pause» in order to read on VU tape meters (if provided) the input level.
- c) Depress Save Selector (Led Save lit) to begin transferring the Program data of the BIT ONE to the tape recorder. The data includes about 30 seconds of pilot signal followed with 2 minutes of real data (sound like a noise).
- d) Adjust the level of the tape recorder between -5 and 0 dB, while the pilot signal is transmitted. Once the data is transmitted the Led of Save selector will switch off, and will appear a «0» on the right side of the display Upper Prog. If you want to repeat this procedure you have to depress the selector Tape.

2. SAVE ON TAPE

- a) Depress Play + Record on tape recorder.
- b) Preceding the data with a voice announcement, via microphone, in order to identify to which group of 63 sounds will correspond the following data.
- c) Depress Save (Led lit).
- d) Wait the end of the transmission, controlling the recording.
- e) Repeat the recording of the data more than once, just in case you have some failings on tape. After this operation the entire sound memory of the BIT ONE has been «copied» on tape and then you can proceed to create 63 new sounds.

LOADING DATA INTO THE BIT ONE.

IMPORTANT!!! WHEN YOU LOAD FROM TAPE YOU WILL ERASE ALL THE DATA EXISTING IN THE SOUND MEMORY, SUBSTITUTING IT WITH A NEW GROUP OF SOUNDS.
BEFORE PROCEEDING TO LOAD, MAKE SURE THAT THE SOUND MEMORY DOES NOT CONTAIN ANY PROGRAM OF YOUR INTEREST.

- a) Connect the output of the tape recorder (Line/aux out) to the input Tape In of the BIT ONE. (If the tape recorder is Stereo, connect only one channel in order to avoid phase problem and azimuth of the heads).
- b) Set the tape at beginning (here, it is very useful your voice announcement), about 6/8 seconds before the pilot signal.
- c) Depress Tape selector (Led lit).
- d) Depress Load selector (Led lit).
- e) Depress «Play» on the tape recorder. The Led of Load selector will remain lit during all the data loading.

At the end of the transmission it will appear a number on the right display of the Upper Prog. This number can be 0 or 1 or 2 or 3.

0 means that everything is OK.

1 means that something is wrong on the connection: check it.

2 means that some kind of reduction noise system is on (like Dolby), therefore switch it off.

3 means that the output level of the tape recorder is too high or too low; or you have a fail on the tape.

If the loading is OK depress the Tape selector (Led off) and the BIT ONE will set itself on preset n. 1 of Lower Prog.

Now the sound memory of the BIT ONE is loaded with 63 new sounds.

MUSICAL INSTRUMENT DIGITAL INTERFACE (M.I.D.I.)

The Musical Instrument Digital Interface is a «universal language» which allows different types of musical equipment to talk to each other. It is the result of an agreement between many musical instrument manufacturers. It provides a uniform set of hardware and software specifications for linking many kinds of equipment for performance, studio use and other purpose. MIDI compatible equipment can include synthesizers, sequencers, rhythm unit personal computers, and other type of products. The optional 5 pin DIN style MIDI connecting cable should be used for connecting the BIT ONE to other MIDI compatible unit (maximum length: 15 meters (50")).

SEQUENCER THAT CONTROL SYNTHESIZERS

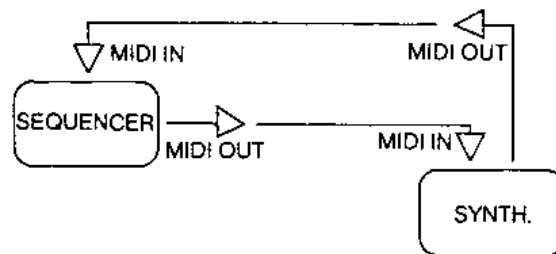

MANY SYNTHESIZERS CONTROLLED BY A KEYBOARD

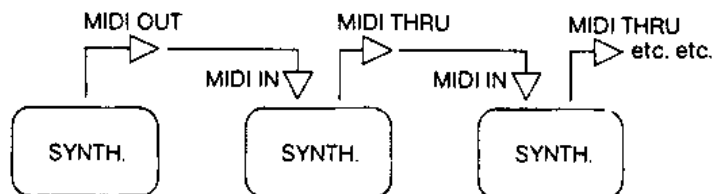

For each key played on the first keyboard, it corresponds the same note emitted from the others.

SYNTHESIZERS OR SEQUENCERS THAT CONTROL EXPANDERS.

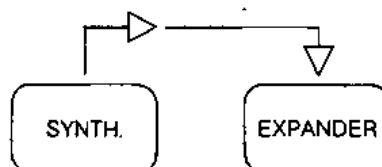

An «Expander» is a synthesizer without keyboard that receive all the informations relative to played key, trigger, program number etc trough the MIDI interface. (Refer to chapter BIT ONE: THE FUTURE).

SYNTHESIZERS CONTROLLED BY PERSONAL COMPUTERS

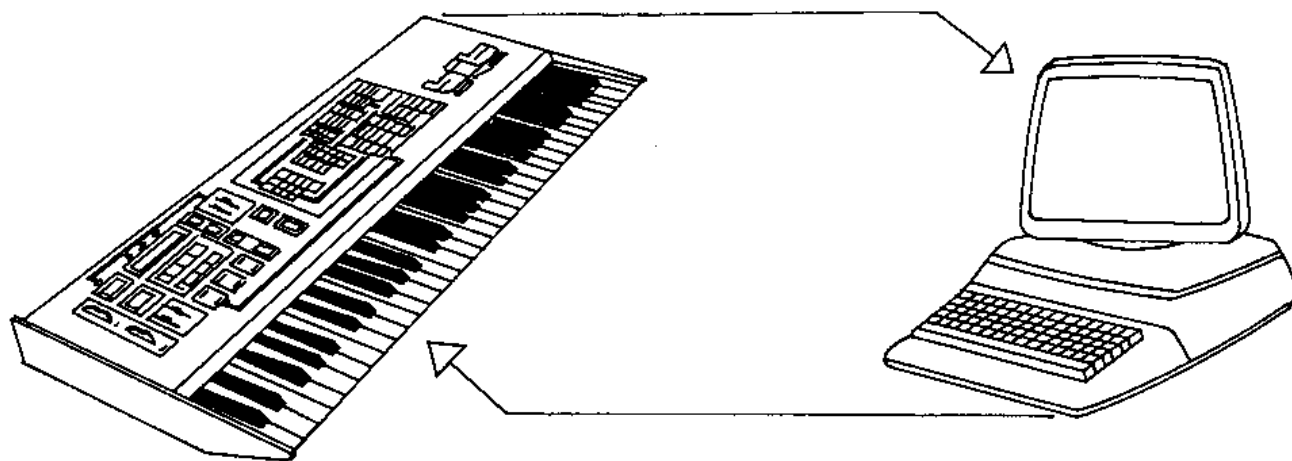

Each MIDI compatible instrument is equipped with at least two MIDI jacks:
MIDI OUT from which come out all the informations.
MIDI IN for the access of the informations coming from outside.
Often is also available a MIDI THRU which is like a bridge between MIDI IN and MIDI OUT.

BIT ONE MIDI



IMPORTANT

When you switch on the BIT ONE, do not press any key for at least 5 seconds. This will allow the Bit One to position its keyboard according to the MIDI specifications. However it is possible to transpose the entire keyboard 1 octave up or down (even by means of semitones) by simply doing the following operations: before switching on the Bit One press the key on which you want to position the keyboard, then turn on the Bit One holding that key for at least 5 seconds.

(Eg. in order to transpose the keyboard 1 octave higher, switch on the instrument holding the 3rd C (DO) from left, to transpose it 1 octave lower, press the 1st C (DO).

BIT-ONE PRESENT MIDI IMPLEMENTATION

TRANSMISSION (BIT ONE MIDI OUT)

The Bit One can only transmit the Key number and the Velocity Code on Chanel 1. Furthermore, when you switch on the Bit One, it transmit a byte of «Note ON», therefore in order to have a right MIDI compatibility with the unit you want to connect, you have to procede as follow: 1) Switch on the other unit. 2) Connect the MIDI OUT of the Bit One and the MIDI IN of the other unit. 3) Switch on the Bit One. The Bit one **cannot transmit** the Program Change, the 16 Channels Assigation, the Pitch Bending and the Modulation. Only Key number and Velocity Code on Chanel 1.

RECEPTION (BIT ONE MIDI IN)

In Reception the Bit One is programmed to receive only in Omni Mode or on Chanel 1. The Master keyboard **can change** its Programs. When MIDI IN is connected, the keyboard of the Bit One is disconnected from the sound source (in other words it is not possible to play the Bit One with its keyboard) however the keyboard can be used to control another unit.

TRANSMISSION DATA

90H status byte «Note ON» (when switch on)

Øxxx xxxx key number (range 36H-96H for default (trasnsposable of 1 octave up or down: 24-84 - 48-108)

Øxxx xxxx key velocity: Ø = key off - 1/127 velocity.

RECEPTION DATA

9ØH note on - Øxxx xxxx key number - Øxxx xxxx velocity

8ØH note off - Øxxx xxxx code - Øxxx xxxx velocity

CØH program change (lower) - Øppp pppp program number (0/61)

BØH control change - Øccc cccc Ø/122 ignored

Øvvv vvvv 123 all notes off vvv = Ø

Øvvv vvvv 124 Omni Mode off vvv = Ø

Øvvv vvvv 125 Omni Mode on vvv = Ø

126/127 ignored

EXCLUSIVE SYSTEM MESSAGES

FØH - Øiii iii = 25 H CRUMAR identification number - Øddd dddd - Øeee eeee

F7H end of exclusive system.

Øddd dddd = Ø it programs the DOUBLE Øeee eeee = Ø

Øddd dddd = 1 it programs the UNISON Øeee eeee = Ø

Øddd dddd = 2 it programs the SPLIT Øeee eeee = Ø Split off

Øeee eeee = 1/127 Split notes

Øddd dddd = 3 it programs the Program (Upper Change Øeee eeee = Ø/61 program number).

BIT ONE: THE FUTURE

The BIT ONE has been designed as an Open System, Expandable and Renewable without limit. The heart of the BIT ONE is «software» in other words a program of its computer that can be corrected and updated in any moment. The MIDI interface is an open door in order to exchange data with present and future system. The future of the BIT ONE is above all the possibility to expand the system by adding external modules controlled by its keyboard. A significant example of this concept is represented by the BIT 01 Rack Expander.

The MIDI interface allows such a information exchange between musical instruments, based on microprocessors, that will make the concept of «Multikeyboard System» obsolete.

One keyboard is now able to control more than one instrument or modules without keyboard: the Expanders.

In order to double up all the possibilities of the BIT ONE is not necessary to buy another one, whereby you have to pay for the keyboard, the cabinet etc. etc. again. All the circuitry, excluding the keyboard, is available on the Expander BIT 01.

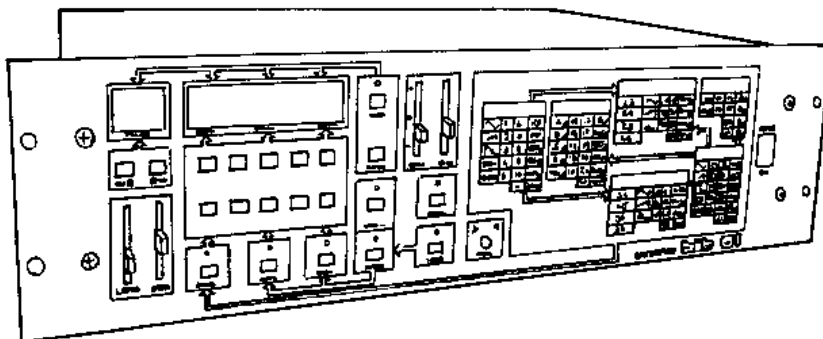

The Expander BIT 01, controlled via MIDI, double up all the possibilities of the BIT ONE, or adds its timbre quality to any other instrument provided with MIDI Out.

1. For each key played in Play Mode on the BIT ONE, will correspond a sound channel on BIT ONE plus a sound channel on BIT 01 Expander.

2. The 3 operative modes Play/Split/Double can be crossed, creating many variant and many combination between the 63 presets of the BIT ONE and the 63 presets of the Expander BIT 01. However, the future of the BIT ONE does not end to the Expander BIT 01; there are already in development a Polyphonic Sequencer, a new Polytimbric Expander, and also Expander for sampling the sound.